



ELEVATE



Motorcycle Equipment
#50

SOMMARIO INDEX

03 L'AZIENDA THE COMPANY

09 NANO SOLLEVATORI MOTO NANO MOTORCYCLE LIFTS

10 Nano 400 Nano 400

12 Nano 600 Nano 600

15 GOLDRAKE SOLLEVATORI MOTO GOLDRAKE MOTORCYCLE LIFTS

16 Goldrake 400 Goldrake 400

18 Goldrake 600 Goldrake 600

20 Goldrake 800 Goldrake 800

22 Goldrake Dark Custom Goldrake Dark Custom

24 Goldrake Quad Goldrake Quad

26 Goldrake Off Road Goldrake Off Road

27 Goldrake e-bike Goldrake E-Bike

28 Kit colore Color kit

29 Manutenzione veicoli elettrici Electric vehicles maintenance

32 Colori ufficiali Case Costruttrici Motorcycle Manufacturers official colors

34 Accessori Accessories

39 ARREDO MODULARE PER OFFICINA WORKSHOP MODULAR FURNITURE

40 Architettura d'officina Workshop architecture

44 Composizioni Configurations

58 Banco sospensioni Suspension bench

60 Banco racing Racing bench

61 Postazione per manutenzione batterie Battery maintenance station

63 CAVALLETTI MOTO PADDOCK STANDS

64 U-Stand U-Stand

70 Diavol Diavol

78 Racing Racing

80 Off-Road Off Road

81 Garage Garage

82 Allestimento furgoni Van equipment

87 ATTREZZATURE E UTENSILERIA GARAGE EQUIPMENTS AND TOOLS

88 Smonta molle per mono ammortizzatore e forcelle Shock-absorber disassembler

89 Smontagomme Tyre changers

90 Equilibratrice statica Static wheel balancer

91 Equilibratrici elettroniche Electronic wheel balancers

92 Vasca lavapezzi Washing tray

93 Presse Presses

94 Utensileria Tools



ELEVATE





**L'AZIENDA
THE COMPANY**



LV8: 50 anni di storia, tecnica e passione

Ferrari Sergio Metalmeccanica, eccellenza italiana fondata nel 1971, inizia a progettare e produrre i primi sollevatori per auto e moto nel 1993. L'innovazione è un must per la Ferrari Sergio Metalmeccanica che nel 2002 dà vita ad un proprio marchio, unico e distintivo: LV8®, oggi market leader nella progettazione, produzione e vendita di attrezzature per officina quali sollevatori per motociclette e auto, accessori e arredo tecnico.

LV8® è fornitore ufficiale di KTM, Husqvarna Motorcycles, Ducati, Piaggio e ha strette collaborazioni con Lamborghini, Dallara, Ferrari, Yamaha, Kawasaki, Honda, Triumph, BMW, Harley Davidson, MV Agusta, Royal Enfield e Kymco. Tutti i prodotti LV8® sono costruiti all'interno del proprio stabilimento, 100% made in Italy, progettati e realizzati internamente con componenti certificati e materiali di alta qualità.



Nasce la Ditta Ferrari Sergio grazie al Sig. Sergio, abile maestro nella lavorazione dei metalli.

1971

A small family company is established by Mr Sergio Ferrari, a skilled and qualified master in metal carpentry.

Produzione delle prime macchine per l'industria alimentare.

1976

First machine production for the food industry.

Ampliamento officina e trasferimento nell'area artigianale di Sorbolo.

1987

Workshop expansion and move to Sorbolo industrial park, near Parma.

Produzione dei primi prodotti finiti per il settore automotive.

1993

First finished products manufacturing for automotive.

Acquisto dei primi centri di lavoro ed impianti di saldatura robotizzata.

1996

First machining centres and robot welding units acquisition.



Follow us on social media

LV8: 50 years of history, technique and passion

Ferrari Sergio Metalmeccanica, Italian excellence founded in 1971, started to design and manufacture the first car and motorcycle lifts in 1993. Innovation is a must for Ferrari Sergio Metalmeccanica, who gave life in 2002 to its own unique and distinctive brand: LV8®, today market leader in design, production and sale of workshop equipment such motorcycle and car lifts, accessories and technical workshop Furniture.

LV8® is the official supplier of KTM, Husqvarna Motorcycles, Ducati, Piaggio, and works closely with Lamborghini, Dallara, Ferrari, Yamaha, Kawasaki, Honda, Triumph, BMW, Harley Davidson, MV Agusta, Royal Enfield and Kymco. All the LV8® products are manufactured in its own facilities, 100% made in Italy, designed and made in-house with certified components and high quality materials.



Costruzione di un nuovo stabilimento annesso al pre-esistente.

Progettazione e produzione della gamma LV8, cavalletti moto e attrezzature da officina.

Nuovo stabilimento di oltre 6000 mq coperti a Brescello (Reggio Emilia).

LV8 presenta ad Automechanika la gamma completa di sollevatori auto e arredo tecnico. Apre inoltre uno showroom di 400 mq dove accogliere i clienti e progettare i loro ambienti di lavoro

LV8 è oggi un marchio di successo nella produzione di attrezzature per moto e auto officine conosciuto e apprezzato in Italia e nel mondo.

2000

2002

2009

2018

TODAY

New plant construction next to the existing one.

Design and manufacturing of LV8 range: motorbike stands and garage equipment.

New plant in Brescello (Reggio Emilia) on a covered area of 6000 sqm.

LV8 introduce at Automechanika the complete range of car lifts and technical furniture. LV8 also open a showroom of 400 sqm where meet Customers and design their working areas.

Nowadays LV8 is a successful and well-known appreciated brand both on the Italian market and worldwide.

Fabio Storchi, Presidente Unindustria Reggio Emilia, celebra in LV8 "IL VALORE DELLA PERSONA, DELL'INGEGNO, DEL LAVORO E DELLA FABBRICA" premiando l'Azienda con l'HOMO FABER 50 di 60, una scultura trofeo in 60 multipli dell'artista Graziano Pompili.



Fabio Storchi, Unindustria Reggio Emilia President, celebrates at LV8 "THE VALUE OF PERSON, INGENUITY, WORK AND FACTORY" rewarding the Company with the HOMO FABER 50 of 60, a sculpture-trophy in 60 multiples of the artist Graziano Pompili



Plant di 6000 mq a Brescello (RE)
Plant of 6000 sqm in Brescello (RE) Italy



PROGETTAZIONE DESIGN

I sollevatori, i cavalletti, le attrezzature e l'arredo tecnico LV8 sono interamente pensati e progettati all'interno della nostra Azienda per aumentare la produttività, efficienza e redditività delle officine. Grazie alle innumerevoli soluzioni di forma, dimensione e colore, sono in grado di rispondere alle diverse esigenze delle officine di tutto il mondo.

The LV8 lifts, paddock stands, equipment and furnishings are entirely conceived and design in our Company in order to increase the workshops' productivity, efficiency and profitability.

Thanks to a wide range of solution in colors, forms and sizes, they are able to comply with the different needs of workshops around the world.



PRODUZIONE PRODUCTION

La produzione di arredi, sollevatori, cavalletti e garage equipment è interamente realizzata nello stabilimento di Brescello (RE) con l'integrazione di componenti Made in Italy. Grande attenzione è riservata alla realizzazione dei componenti speciali, alla verniciatura personalizzata e al premontaggio interno all'Azienda, che contribuisce a garantire la qualità del prodotto che verrà consegnato.

The production of furnishings, lifts, paddock stands and garage equipment is entirely manufactured in the plant of Brescello (Italy) with the integration of components Made in Italy. Particular attention is given to the realization of special components, custom powder coating and pre-assembly within the company, ensuring the quality of the product.



INSTALLAZIONE INSTALLATION

Formazione tecnica, installazione diretta e realizzazione di istruzioni di montaggio particolareggiate completano la nostra offerta di prodotti e servizi volti a garantire la massima qualità e la soddisfazione del Cliente.

Technical training, direct installation on site and implementation of detailed assembly instructions complete our offer of products and services to ensure the highest quality and Customer satisfaction



Showroom di 400 mq a Sorbolo (PR)
Showroom of 400 sqm in Sorbolo (PR) Italy

OUR BUSINESS





NANO

MADE IN ITALY

Interamente progettati, costruiti e collaudati all'interno della ns. Azienda i sollevatori vengono prodotti e assemblati con componenti 100% Made In Italy. Tutte le parti oleodinamiche, idrauliche ed elettriche provengono dalla filiera della Motor Valley Emiliano Romagnola per garantire massima affidabilità, qualità e sicurezza.

MATERIALI

La qualità dei materiali è imprescindibile nel settore del sollevamento, ecco perché utilizziamo materie prime sottoposte ad analisi chimiche, prove meccaniche e test di resistenza, munite di certificati di controllo specifico per garantire la completa rintracciabilità e qualità dei materiali.

MADE IN ITALY

Being entirely designed, built and tested within our firm, our lifts are produced and assembled with 100% Made In Italy components. All oleodynamic, hydraulic and electrical parts come from the production chain of Emilia Romagna's Motor Valley so as to ensure maximum reliability, quality and safety.

MATERIALS

The quality of the materials is essential in the lifting industry, that is why we use raw materials which underwent chemical analysis, mechanical and resistance tests, and which come with specific control certificates so as to guarantee the complete traceability and quality of the materials.

NANO è la linea di sollevatori progettati e costruiti in LV8® disponibile in 2 versioni elettroidrauliche di capacità 400 e 600 kg . La serie NANO è in grado di sintetizzare al meglio design ed elevate prestazioni, garantendo la massima funzionalità e sicurezza in tutte le operazioni di accettazione e manutenzione veicolo. Il sollevatore Nano, grazie ai soli 7,5 cm (3") di altezza da chiuso e la rampa retraibile è il ponte più basso e "compatto" al mondo, adatto per essere utilizzato a pavimento senza dover ricorrere a costose opere murarie per l'incasso in officina. La centralina elettroidraulica, inserita nel totem esterno, può essere perfettamente integrata all'interno dei moduli di arredo LV8® ottenendo uno spazio di lavoro completamente organizzato ed ergonomico. Dotato di sicurezze elettriche ed idrauliche garantisce massima affidabilità sia in salita che in discesa, senza dover intervenire manualmente inserendo e disinserendo leve meccaniche.

NANO is the lift line designed and produced in LV8®, available in 2 electro-hydraulic versions with 400 and 600kg of capacity. The NANO range is able to best concentrate design and elevated performances, ensuring, at the same time, the best functionality and safety during all acceptance and service operations on the vehicle. Thanks to its being only 7,5cm (3") high when closed and its retractable ramp, the Nano lift is the lowest and most "compact" lift in the world, suitable for being installed on the floor without resorting to any expensive construction works to recess it in the workshop. The electro-hydraulic control unit, inside an external box, can be perfectly integrated into our LV8® furniture modules, which allows to attain a completely organized and ergonomic work space. Equipped with both electrical and hydraulic safety devices, the lift guarantees the best reliability both when going up and down, without having to manually intervene by inserting or releasing mechanical levers.

Predisposizione per l'aggiunta di accessori (Morse / estensioni / cinghie)
Set-up for fitting accessories (wheel clamps/ extensions/ ratchet tie downs)

Tutti i perni di snodo sono dotati di bussole autolubrificanti che non necessitano di manutenzione periodica.
All joint linchpins are equipped with self-lubricating bushes which do not need any periodic maintenance

Vasche portautensili
Side tool holders

Altezza d'ingombro a terra (ponte tutto chiuso) di soli 7,5 cm
Only 7.5cm of ground clearance (when closed)

Gate removibile per lo smontaggio agevole delle ruote posteriori
Retractable gate to ease the demounting of rear wheels

Sistema di scorrimento con pattini in materiale plastico autolubrificante
Sliding system with sliding pads in self-lubricating plastic material

Rampa di salita a scomparsa
Retractable ramp

Sistema di sicurezza idraulico certificato che permette senza vincoli infinite regolazioni dell'altezza della piattaforma
Certified hydraulic safety system which allows infinite height adjustments of the platform

Sistema idraulico a doppio cilindro dotato di stelo cromato con sistema di autolubrificazione delle guarnizioni
Hydraulic system with double cylinder equipped with a self-lubricating system for the seals

Quadro Comandi operatore in bassa tensione 24v con interruttore interbloccato di sicurezza
"Dead man" controls 24V with interlocked safety switch

Centralina elettroidraulica esterna con comandi dedicati posta in mobiletto direttamente collegato al ponte sollevatore (centralina integrabile nell'arredamento tecnico LV8)
External electro-hydraulic control unit put inside a small cabinet and directly connected to the lift (control unit which can also be integrated into our LV8 technical furniture)

TÜV

I nostri sollevatori si fregiano della certificazione CE rilasciata dal TÜV e Bureau Veritas , ampiamente riconosciuti in tutto il mondo e rispettati quali simboli accreditati di qualità, sicurezza e sostenibilità

TÜV

Our lifts boast a CE certification issued by TÜV and Bureau Veritas, which are widely acknowledged worldwide and are respected as accredited symbols of quality, safety and sustainability.

PLUG & PLAY

Al momento della consegna i nostri sollevatori possono essere immediatamente collegati e messi in funzione con estrema facilità, senza alcun intervento di installazione.

PLUG & PLAY

Once they are delivered, our lifts can be immediately plugged in and easily activated, without any installation operation needed.



NANO 400



EN400GE SOLLEVATORE NANO 400

NANO 400 LIFT

Caratteristiche tecniche

- Comandi uomo presente, 24V
- Sicurezze elettriche
- Sicurezze idrauliche
- Portata 400kg
- Alimentazione Elettrica 220V 1ph
- Adatto per essere installato a pavimento o a scomparsa
- Completo di tubazioni idrauliche lung. 2 mt premontate per installazione centralina
- Base e leve allargate
- Uscita tubi anteriore

Dotazioni di serie

- 2 vaschette porta utensili laterali
- Rampa di salita a scomparsa
- Fermaruota
- Carter per protezione tubazioni

Technical Features

- "Dead man" controls 24V
- Electrical safety devices
- Hydraulic safety devices
- Capacity 400Kg
- Power Supply 220V 1 ph
- Suitable for recessed installation or on the floor
- Equipped with pre-mounted hydraulic pipes length 2 mt. enabling the installation of the control unit
- Base and levers extended
- Front output pipes

Standard Equipments

- 2 side tools holders
- Retractable run-up ramp
- Front safety bar
- Pipe protection cover

Altezza minima 75 mm (3").
Il sollevatore più basso al mondo!
Minimum height 75 mm (3").
The lowest motorbike lift in the world!
The one and only with hydraulic safety device!



Portata Capacity	400 kg
Altezza max Max height	1030 mm
Altezza min Min height	75 mm
Larghezza pianale Platform width	650 mm
Lunghezza pianale Platform length	2000 mm
Larghezza rampa Ramp width	466 mm
Lunghezza rampa Ramp length	298 mm

STANDARD EQUIPMENT



Centralina elettroidraulica in mobiletto esterno
Electro-Hydraulic unit in external cabinet



Pattini in materiale plastico autolubrificante
Pads in self-lubricating plastic material



Rampa di salita a scomparsa
Retractable ramp



Gate removibile 28x50 cm
Removable gate 28x50 cm



Predisposizione per l'integrazione di accessori
Set-up for fitting accessories



Due cilindri di sollevamento
Two lifting cylinders

OPTION



ENEF350

Cornice ad incasso
cm 204x68xH8
In ground frame
cm 204x68xH8



EN350G.17L

Rampa larga (65x30 cm)
Large ramp (65x30 cm)



EN400FEK

Estensione frontale per pianale
cm. 65x35
Front Extension cm. 65x35



EIE-LTPNK01

Kit radiocomando
Remote control kit

CUSTOMIZE YOUR COLOR!



Personalizza il tuo sollevatore con i nostri kit colore
Customize your lift with our colour kits

GO TO PAGE ► 28

SAFETY FIRST!



Rendi il tuo sollevatore idoneo alla manutenzione delle moto elettriche
Make your lift suitable for maintenance work on electric motorcycles

GO TO PAGE ► 29

ADD THE ACCESSORIES!

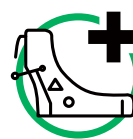

Seleziona gli accessori da aggiungere al sollevatore
Select the accessories you want to add to the lift

GO TO PAGE ► 34

OFFICIAL BRANDS



...and others

GO TO PAGE ► 32

NANO 600



EN600GE SOLLEVATORE NANO 600

NANO 600 LIFT

Caratteristiche tecniche

- Comandi uomo presente, 24V
- Sicurezze elettriche
- Sicurezze idrauliche
- Portata 600kg
- Alimentazione Elettrica 220V 1ph
- Adatto per essere installato a pavimento o a scomparsa
- Completo di tubazioni idrauliche lung. 2 mt premontate per installazione centralina
- Base e leve allargate
- Uscita tubi anteriore

Dotazioni di serie

- 2 vaschette porta utensili laterali
- Rampa di salita a scomparsa
- Ferma ruota
- Carter per protezione tubazioni

Technical Features

- "Dead man" controls 24V
- Electrical safety devices
- Hydraulic safety devices
- Capacity 600Kg
- Power Supply 220V 1 ph
- Suitable for recessed installation or on the floor
- Equipped with pre-mounted hydraulic pipes length 2 mt. enabling the installation of the control unit
- Base and levers extended
- Front output pipes

Standard Equipments

- 2 side tools holders
- Retractable run-up ramp
- Front safety bar
- Pipe protection cover

Altezza minima 75 mm (3").
Il sollevatore più basso al mondo!
Minimum height 75 mm (3").

The lowest motorbike lift in the world!
The one and only with hydraulic safety device!



Portata Capacity	600 kg
Altezza max Max height	1030 mm
Altezza min Min height	75 mm
Larghezza pianale Platform width	750 mm
Lunghezza pianale Platform length	2200 mm
Larghezza rampa Ramp width	466 mm
Lunghezza rampa Ramp length	298 mm

STANDARD EQUIPMENT



Centralina elettroidraulica in mobiletto esterno
Electro-Hydraulic unit in external cabinet



Pattini in materiale plastico autolubrificante
Pads in self-lubricating plastic material



Rampa di salita a scomparsa
Retractable ramp



Gate removibile 35x60 cm
Removable gate 35x60 cm



Predisposizione per l'integrazione di accessori
Set-up for fitting accessories



Due cilindri di sollevamento
Two lifting cylinders

OPTION



ENEF500

Cornice ad incasso
cm 224x79xH8
In ground frame
cm 224x79xH8



EN500G.17L

Rampa larga (75x30 cm)
Large ramp (75x30 cm)



EG600FEK

Front Extension per pianale
cm. 75x35
Front Extension cm. 75x35



EIE-LTPNK01

Kit radiocomando
Remote control kit

CUSTOMIZE YOUR COLOR!



Personalizza il tuo sollevatore con i nostri kit colore
Customize your lift with our colour kits

GO TO PAGE ► 28

SAFETY FIRST!



Rendi il tuo sollevatore idoneo alla manutenzione delle moto elettriche
Make your lift suitable for maintenance work on electric motorcycles

GO TO PAGE ► 29

ADD THE ACCESSORIES!

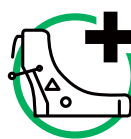

Seleziona gli accessori da aggiungere al sollevatore
Select the accessories you want to add to the lift

GO TO PAGE ► 34

OFFICIAL BRANDS



...and others

GO TO PAGE ► 32



GOLDRAKE

MADE IN ITALY

Interamente progettati, costruiti e collaudati all'interno della ns. Azienda i sollevatori vengono prodotti e assemblati con componenti 100% Made In Italy. Tutte le parti oleodinamiche, idrauliche ed elettriche provengono dalla filiera della Motor Valley Emiliano Romagnola per garantire massima affidabilità, qualità e sicurezza.

MATERIALI

La qualità dei materiali è imprescindibile nel settore del sollevamento, ecco perché utilizziamo materie prime sottoposte ad analisi chimiche, prove meccaniche e test di resistenza, munite di certificati di controllo specifico per garantire la completa rintracciabilità e qualità dei materiali.

MADE IN ITALY

Being entirely designed, built and tested within our firm, our lifts are produced and assembled with 100% Made In Italy components. All oleodynamic, hydraulic and electrical parts come from the production chain of Emilia Romagna's Motor Valley so as to ensure maximum reliability, quality and safety.

MATERIALS

The quality of the materials is essential in the lifting industry, that is why we use raw materials which underwent chemical analysis, mechanical and resistance tests, and which come with specific control certificates so as to guarantee the complete traceability and quality of the materials.

GOLDRAKE è la serie di sollevatori progettati e costruiti in LV8® per operare su qualsiasi veicolo a 2, 3 e 4 ruote, dalle e-bike agli scooter, dalle moto sportive e custom sino ai quad e ATV. Disponibile in diverse versioni e modelli con capacità 200/400/600/800 kg rappresenta la migliore soluzione per chi cerca tradizione e affidabilità.

Una vasta gamma di accessori e optional, oltre a tutte le opzioni di motorizzazione (dalla pompa a pedale e ad aria alla centralina elettroidraulica con comando remoto), lo rendono un sollevatore assolutamente versatile, adatto sia per l'installazione a pavimento sia per l'incasso.

GOLDRAKE is the lift line designed and produced in LV8® to work on any two-three-four-wheeled vehicle, ranging from e-bikes to scooters, from sports and custom motorbikes to quads and ATV. Available in different versions and models with 200/400/600/800kg of capacity, it is the best solution to whoever is looking for tradition and reliability.

Its large accessory and optional array, as well as all its available engine types (from the foot pedal and hydraulic air pump to the electro-hydraulic unit with remote control) make it an absolutely versatile lift, suitable both for the installation on the floor and for floor recession.

Predisposizione per l'aggiunta di accessori (Morse / estensioni / cinghie)
Set-up for fitting accessories (wheel clamps/ extensions/ ratchet tie downs)

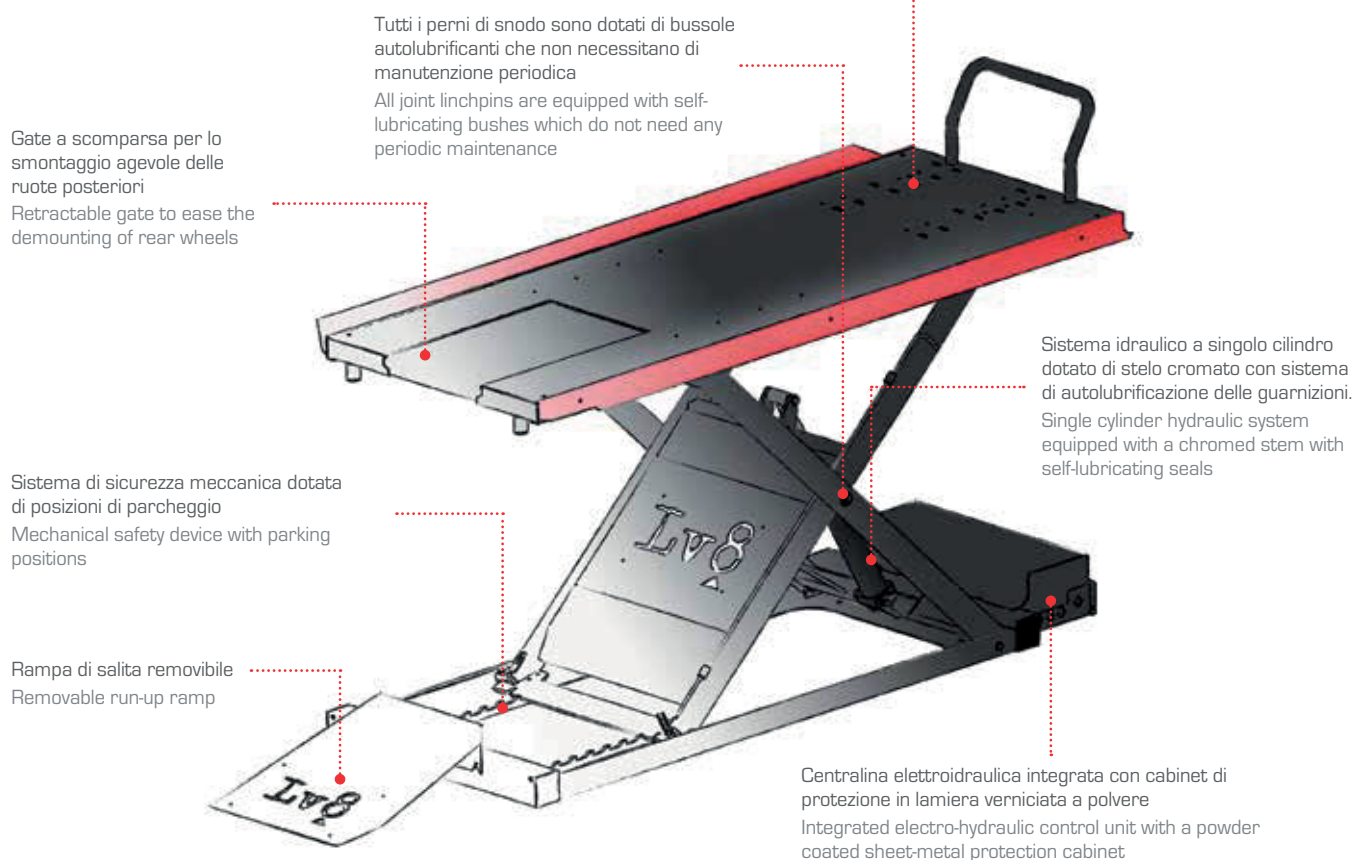

TÜV

I nostri sollevatori si fregiano della certificazione CE rilasciata dal TÜV e Bureau Veritas, ampiamente riconosciuti in tutto il mondo e rispettati quali simboli accreditati di qualità, sicurezza e sostenibilità

TÜV

Our lifts boast a CE certification issued by TÜV and Bureau Veritas, which are widely acknowledged worldwide and are respected as accredited symbols of quality, safety and sustainability.

PLUG & PLAY

Al momento della consegna i nostri sollevatori possono essere immediatamente collegati e messi in funzione con estrema facilità, senza alcun intervento di installazione.

PLUG & PLAY

Once they are delivered, our lifts can be immediately plugged in and easily activated, without any installation operation needed.

GOLDRAKE 400



SOLLEVATORE GOLDRAKE 400

GOLDRAKE 400 LIFT

MODEL	 Centralina elettroidraulica Electro-hydraulic unit	 Pompa a pedale Foot pump	 Pompa ad aria Air pump
EG400E	✓	-	-
EG400P	-	✓	-
EG4000	-	-	✓

Caratteristiche tecniche

- Sicurezze elettriche
- Sicurezze meccaniche
- Sicurezze idrauliche
- Portata: 400kg
- Tre opzioni di motorizzazione (centralina elettroidraulica, pompa a pedale o ad aria)
- Comandi operatore in bassa tensione 24v

Dotazioni di serie

- 2 vaschette porta utensili laterali
- Rampa di salita
- Ferma ruota

Technical Features

- Electrical Safety device
- Mechanical safety device
- Hydraulic safety devices
- Capacity: 400kg
- Three option of motors (electro-hydraulic unit, foot or air pump)
- "Dead man" controls 24V

Standard Equipments

- 2 side tools holders
- Run-up ramp
- Front safety bar



Portata Capacity	400 kg
Altezza max Max height	1100 mm
Altezza min Min height	180 mm
Larghezza pianale Platform width	600 mm
Lunghezza pianale Platform length	2000 mm
Larghezza rampa Ramp width	450 mm
Lunghezza rampa Ramp length	575 mm

STANDARD EQUIPMENT



Sicurezza meccanica con posizioni di parcheggio
Mechanical safety device with parking positions



Un cilindro di sollevamento
One lifting cylinder



Rampa di salita removibile
Removable run-up ramp

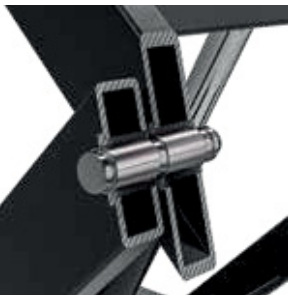

Boccole autolubrificanti
Skid sliding system with self-lubricating plastic material

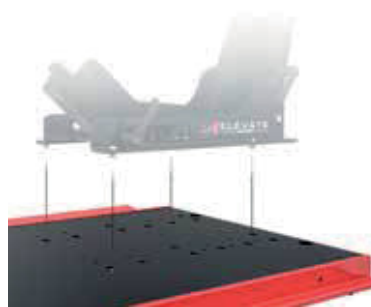

Predisposizione per l'integrazione di accessori
Set-up for fitting accessories

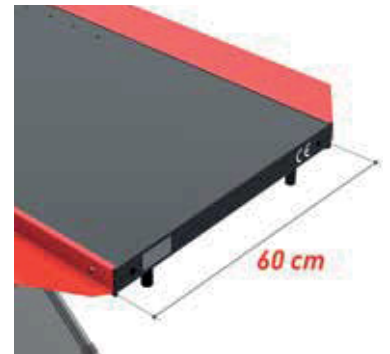

Piano di lavoro di soli 60 cm per massima accessibilità alle parti laterali della moto
Worktop of only 60 cm for the best accessibility to the bike side parts

OPTION

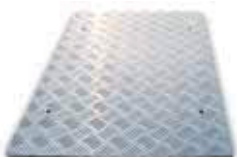

Lamiera alluminio antiscivolo
Antiskid aluminium platform



EG350.7L

Rampa larga 400 (60x80cm)
Large ramp 400 (60x80cm)



EG400FEK

Front Extension per pianale
cm. 60x35
Front Extension cm. 60x35



EIE-LTPNK01

Kit radiocomando
Remote control kit

CUSTOMIZE YOUR COLOR!



Personalizza il tuo sollevatore con i nostri kit colore
Customize your lift with our colour kits

GO TO PAGE ► 28

SAFETY FIRST!



Rendi il tuo sollevatore idoneo alla manutenzione delle moto elettriche
Make your lift suitable for maintenance work on electric motorcycles

GO TO PAGE ► 29

ADD THE ACCESSORIES!

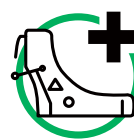

Seleziona gli accessori da aggiungere al sollevatore
Select the accessories you want to add to the lift

GO TO PAGE ► 34

OFFICIAL BRANDS



...and others

GO TO PAGE ► 32

GOLDRAKE 600



SOLLEVATORE GOLDRAKE 600

GOLDRAKE 600 LIFT

Con centralina elettroidraulica
With electro-hydraulic unit

Caratteristiche tecniche

- Sicurezze elettriche
- Sicurezze meccaniche
- Sicurezze idrauliche
- Portata: 600kg
- Centralina elettroidraulica integrata
- Comandi operatore in bassa tensione 24v

Dotazioni di serie

- 2 vaschette porta utensili laterali
- Rampa di salita
- Fermaruota

Technical Features

- Electrical Safety device
- Mechanical safety device
- Hydraulic safety devices
- Capacity: 600kg
- Integrated electro-hydraulic unit
- "Dead man" controls 24V

Standard Equipments

- 2 side tools holders
- Run-up ramp
- Front safety bar

MODEL	FLOOR VERS.	INGROUND VERS.	MAX HEIGHT (cm)	GATE	RAMP, TOOLS HOLDER KIT	COLOR KIT	ISOL8 VERS.
EG600CE	✓	-	110	✓	✓	✓	✓
EG600HCE	✓	-	130	✓	✓	✓	✓
EG600HCFE	-	✓	130	✓	-	-	✓



Portata Capacity	600 kg
Altezza max Max height	1100 mm/1300 mm
Altezza min Min height	180 mm
Larghezza pianale Platform width	750 mm
Lunghezza pianale Platform length	2100 mm
Larghezza rampa Ramp width	450 mm
Lunghezza rampa Ramp length	575 mm

STANDARD EQUIPMENT



Centralina elettroidraulica con pulsantiera dotata di magnete
Electro-hydraulic unit with hand control equipped with magnet



Gate a scomparsa 35x60 cm
Retractable gate 35x60 cm



Un cilindro di sollevamento
One lifting cylinder

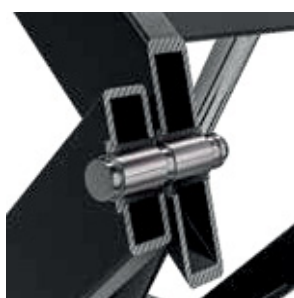

Boccole autolubrificanti
Skid sliding system with self-lubricating plastic material



Predisposizione per l'integrazione di accessori
Set-up for fitting accessories



Sicurezza meccanica con posizioni di parcheggio
Mechanical safety device with parking positions

OPTION



EGHCF600

Cornice ad incasso
cm 214x9xH18
In ground frame
cm 214x79xH18



EG600.7L

Rampa larga (75x80 cm)
Large ramp (75x80 cm)



EG600FEK

Front Extension per pianale
cm.75x35
Front Extension cm.75x35



EIE-LTPNK01

Kit radiocomando
Remote control kit

CUSTOMIZE YOUR COLOR!



Personalizza il tuo sollevatore con i nostri kit colore
Customize your lift with our colour kits

GO TO PAGE ► 28

SAFETY FIRST!



Rendi il tuo sollevatore idoneo alla manutenzione delle moto elettriche
Make your lift suitable for maintenance work on electric motorcycles

GO TO PAGE ► 29

ADD THE ACCESSORIES!

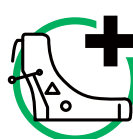

Seleziona gli accessori da aggiungere al sollevatore
Select the accessories you want to add to the lift

GO TO PAGE ► 34

OFFICIAL BRANDS



...and others

GO TO PAGE ► 32

GOLDRAKE 800



SOLLEVATORE GOLDRAKE 800

GOLDRAKE 800 LIFT
Con centralina elettroidraulica
With electro-hydraulic unit

Caratteristiche tecniche

- Sicurezze elettriche
- Sicurezze meccaniche
- Sicurezze idrauliche
- Portata: 800kg
- Centralina elettroidraulica integrata

Dotazioni di serie

- 2 vaschette porta utensili laterali
- Rampa di salita
- Ferma ruota

Technical Features

- Electrical Safety device
- Mechanical safety device
- Hydraulic safety devices
- Capacity: 800kg
- Integrated electro-hydraulic unit

Standard Equipments

- 2 side tools holders
- Run-up ramp
- Front safety bar

MODEL	FLOOR VERS.	INGROUND VERS.	MAX HEIGHT (cm)	GATE	RAMP, TOOLS HOLDER KIT	COLOR KIT	ISOL8 VERS.
EG800HCE	✓	-	130	✓	✓	✓	✓
EG800HCFE	-	✓	130	✓	-	-	✓



Portata Capacity	800 kg
Altezza max Max height	1300 mm
Altezza min Min height	180 mm
Larghezza pianale Platform width	750 mm
Lunghezza pianale Platform length	2200 mm
Larghezza rampa Ramp width	450 mm
Lunghezza rampa Ramp length	575 mm

STANDARD EQUIPMENT



Centralina elettroidraulica con pulsantiera dotata di magnete
Electro-hydraulic unit with hand control equipped with magnet



Gate a scomparsa 35x60 cm
Retractable gate 35x60 cm



Un cilindro di sollevamento
One lifting cylinder



Boccole autolubrificanti
Skid sliding system with self-lubricating plastic material



Predisposizione per l'integrazione di accessori
Set-up for fitting accessories



Sicurezza meccanica con posizioni di parcheggio
Mechanical safety device with parking positions

OPTION



EGHCF800

Cornice ad incasso
cm 224x79xH18
In ground frame
cm 224x79xH18



EG800SET

Kit ali di allargamento per veicoli a 3 ruote (TRIKE)
Side extensions kit for 3 wheels vehicles (TRIKE).

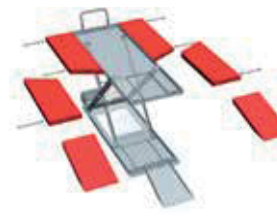

EG800SECA

Kit ali di allargamento scomponibili in due parti per veicoli a 3 ruote (CAN-AM).
Side extensions kit for 3 wheels vehicles (CAN-AM).



EIE-LTPNK01

Kit radiocomando
Remote control kit

CUSTOMIZE YOUR COLOR!

Personalizza il tuo sollevatore con i nostri kit colore
Customize your lift with our colour kits

GO TO PAGE ► 28

SAFETY FIRST!

Rendi il tuo sollevatore idoneo alla manutenzione delle moto elettriche
Make your lift suitable for maintenance work on electric motorcycles

GO TO PAGE ► 29

ADD THE ACCESSORIES!

Seleziona gli accessori da aggiungere al sollevatore
Select the accessories you want to add to the lift

GO TO PAGE ► 34

OFFICIAL BRANDS

...and others

GO TO PAGE ► 32

GOLDRAKE DARK CUSTOM



EG803HCFE SOLLEVATORE GOLDRAKE DARK CUSTOM

GOLDRAKE DARK CUSTOM LIFT

Con centralina elettroidraulica
With electro-hydraulic unit

Caratteristiche tecniche

- Sicurezze elettriche
- Sicurezze idrauliche
- Portata: 800kg
- Centralina elettroidraulica integrata
- Comandi operatore in bassa tensione 24v

Technical Features

- Electrical Safety device
- Hydraulic safety devices
- Capacity: 800 kg
- Integrated electro-hydraulic unit
- "Dead man" controls 24V



Portata Capacity	800 kg
Altezza max Max height	1300 mm
Altezza min Min height	180 mm
Larghezza pianale Platform width	828 mm
Lunghezza pianale Platform length	2450 mm
Larghezza rampa Ramp width	450 mm
Lunghezza rampa Ramp length	575 mm

STANDARD EQUIPMENT



Centralina elettroidraulica con pulsantiera dotata di magnete
Electro-hydraulic unit with hand control equipped with magnet



Gate per smontaggio della ruota posteriore, a movimento basculante
Tilting gate for front tyre changer



Due cilindri di sollevamento
Two lifting cylinders

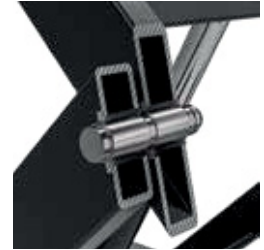

Boccole autolubrificanti
Skid sliding system with self-lubricating plastic material



Pulsantiera a cavo con magnete e predisposto per il montaggio del kit radiocomando wifi LV8
Wire remote control unit with magnet and arranged for assembling the LV8 wi-fi remote control kit



Kit presa di corrente ausiliaria shuko su box centralina
Kit for additional schuko socket on power unit box



Protezione anti schiacciamento piedi "foot guard" device protection



Kit slitta scorrevole su guide in nylon per alloggiamento cavalletto E500C
Kit sliding sled on nylon glide for E500C stand positioning



Kit di 4 ganci scorrevoli per fissaggio cinghie
Kit of 4 sliding hooks for belts fastening



Kit di 2 vaschette portautensili scorrevoli lunghi 50cm ciascuna
Kit of 2 sliding tool holders 50cm length/each



Kit golfari per pianale per serraggio cinghie
Kit of platform's eyebolts for belts fastening



Kit attacco rapido aria compressa sul pianale
Quick-release coupling for compressed air on the platform

OPTION



EGHCH803

Cornice ad incasso
cm 249x90xH18
In ground frame
cm 249x90xH18



EIE-LTPNK01

Kit radiocomando
Remote control kit

ADD THE ACCESSORIES!

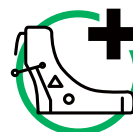

Seleziona gli accessori da aggiungere al sollevatore
Select the accessories you want to add to the lift

GO TO PAGE ► 34

OFFICIAL BRANDS



...and others

GO TO PAGE ► 32

GOLDRAKE QUAD



SOLLEVATORE GOLDRAKE QUAD

GOLDRAKE QUAD LIFT

Sollevatore per Quad, ATV, tosaerba e motoslitte
Quad, ATV, lawn mover and snowcat lift

Caratteristiche tecniche

- Sicurezze elettriche
- Sicurezze meccaniche
- Sicurezze idrauliche
- Portata: 600 kg
- Centralina elettroidraulica integrata

Dotazioni di serie

- 2 rampe di salita
- 2 fermapuota

Technical Features

- Electric Safety device
- Mechanical Safety device
- Hydraulic safety device
- Capacity 600 kg
- Integrated electro-hydraulic unit

Standard Equipments

- 2 run-up ramps
- 2 front safety bars

MODEL	 Centralina elettroidraulica Electro-hydraulic unit	 Pompa a pedale Foot pump	 Pompa ad aria Air pump
EG600QE	✓	-	-
EG600QP	-	✓	-
EG600QO	-	-	✓



Portata Capacity	600 kg
Altezza max Max height	1100 mm
Altezza min Min height	180 mm
Larghezza pianale Platform width	1450 mm
Lunghezza pianale Platform length	2300 mm
Larghezza rampa Ramp width	360 mm
Lunghezza rampa Ramp length	793 mm

STANDARD EQUIPMENT



Due rampe di salita
Two run-up ramps



Gate centrale per lavori
sottoscocca
Central gate for underbody jobs



Fermaruota per veicoli a 2-3-4
ruote.
Safety bars for 2-3-4 wheels
vehicles



Boccole autolubrificanti
Skid sliding system with self-
lubricating plastic material



Un cilindro di sollevamento
One lifting cylinder



Sicurezza meccanica con posizioni di
parcheggio
Mechanical safety device with parking
positions

OPTION



EG400Q-R3

Rampa centrale
per veicoli a tre ruote
Central ramp
for 3-wheeler-vehicles



EIE-LTPNK01

Kit radiocomando
Remote control kit

CUSTOMIZE YOUR COLOR!



Personalizza il tuo sollevatore
con i nostri kit colore
Customize your lift with our
colour kits

GO TO PAGE ► 28

SAFETY FIRST!



Rendi il tuo sollevatore idoneo alla
manutenzione delle moto elettriche
Make your lift suitable for
maintenance work on electric
motorcycles

GO TO PAGE ► 29

ADD THE ACCESSORIES!

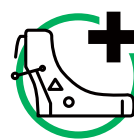

Seleziona gli accessori da
aggiungere al sollevatore
Select the accessories you want
to add to the lift

GO TO PAGE ► 34

OFFICIAL BRANDS



...and others

GO TO PAGE ► 32



GOLDRAKE OFF ROAD

STANDARD EQUIPMENT



Centralina elettroidraulica con pulsantiera dotata di magnete
Electro-hydraulic unit with hand control equipped with magnet



Rotante 360°con interblocchi
360° turnable with interlocking

OPTION



EIE-LTPNK01

Kit radiocomando
Remote control kit



EG500XE SOLLEVATORE GOLDRAKE OFF ROAD

GOLDRAKE OFF ROAD LIFT

Caratteristiche tecniche

- Comandi uomo presente, 24V
- Sicurezze elettriche
- Sicurezze idrauliche
- Portata: 500kg
- Alimentazione Elettrica 220V 1ph
- Centralina elettroidraulica integrata
- Piano Rotante 360°con interblocchi

Technical Features

- "Dead man" controls 24V
- Electrical Safety device
- Hydraulic safety devices
- Capacity: 500 kg
- Power Supply 220V 1 ph
- Integrated electro-hydraulic unit
- 360°Turnable table with interlocking



Portata Capacity	500 kg
Altezza max Max height	1125 mm
Altezza min Min height	195 mm
Larghezza pianale Platform width	470 mm
Lunghezza pianale Platform length	350 mm
Larghezza rampa Ramp width	-
Lunghezza rampa Ramp length	-

GOLDRAKE E-BIKE



Rampa rimovibile
Removable ramp

OPTION



EG200JP-VP

Vaschette portautensili optional
Optional tools holders



SOLLEVATORE GOLDRAKE E-BIKE

GOLDRAKE E-BIKE LIFT

Caratteristiche tecniche

- Sicurezze idrauliche
- Portata: 200kg

Dotazioni di serie

- Rampa di salita

Technical Features

- Hydraulic safety devices
- Capacity: 200 kg

Standard Equipments:

- Run-up ramp

MODEL	 Pompa a pedale Foot pump	 Pompa ad aria Air pump
EG200JP	✓	-
EG200JO	-	✓



Portata Capacity	200 kg
Altezza max Max height	1000 mm
Altezza min Min height	190 mm
Larghezza pianale Platform width	550 mm
Lunghezza pianale Platform length	1900 mm
Larghezza rampa Ramp width	250 mm
Lunghezza rampa Ramp length	575 mm

COLOR KIT

Personalizza il tuo sollevatore scegliendo il kit colore preferito tra quelli sotto riportati. Vaschette portautensili e rampa colorati, ferma ruota nero sono gli elementi che compongono ogni kit colore.

Customize your lift by choosing the favorite color kit among those listed below. Colored tools holder kit and ramp, black wheel stopper are the elements included in each color kit.

AVAILABLE COLORS



**Vaschette Portautensili
Tools Holder Kit**



**SCEGLI LO STILE PIU' ADATTO A TE!
Chose your own style!**

Colors kit are available for both Nano and Goldrake lifts

HOW IS YOUR LIFT PACKED?

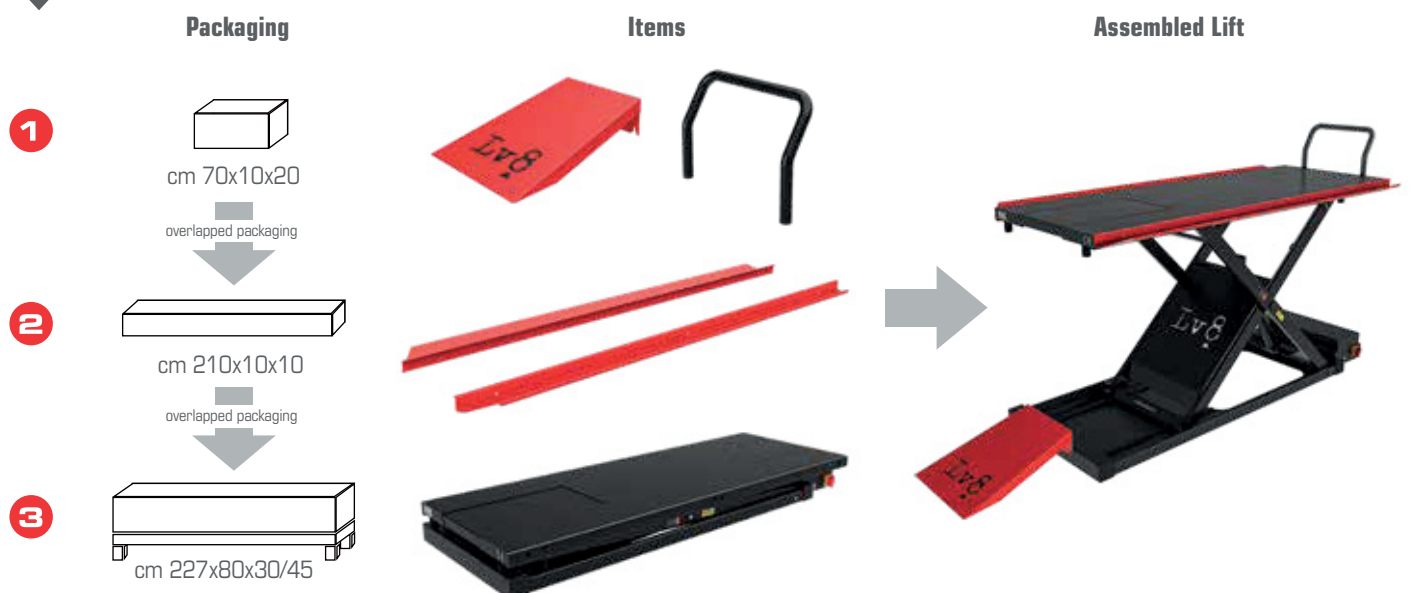

ELECTRIC VEHICLES MAINTENANCE

La sicurezza sul lavoro è un tema molto importante e rappresenta un fattore determinante di competitività e sviluppo. ISOL8 è il primo e l'unico trattamento superficiale al mondo, studiato in LV8, per poter isolare elettricamente le superfici di lavoro e renderle idonee alla manutenzione dei veicoli elettrici. Tutti i nostri sollevatori possono essere ordinati a richiesta con il trattamento speciale ISOL8.

Work's safety is a very important topic and represents a main factor of competitiveness and development. ISOL8 is the first and only treatment in the world, studied in LV8, in order to electrically isolate the work surfaces and make them suitable for the service of electric vehicles. All our lifts can be ordered on request with the special ISOL8 treatment.

**RIVESTIMENTO SPECIALE
SPECIAL COATING**



**LAVORA IN TUTTA SICUREZZA!
WORK SAFELY!**



SURFACE TECHNICAL DATA

Lo speciale rivestimenti ISOL8 del pianale, gate e vaschette portautensili conferisce alla superficie resistenza all'elettricità, all'abrasione e corrosione dalla maggior parte degli agenti chimici. La finitura superficiale inoltre ne conferisce elevate proprietà antiscivolo.

The ISOL8 special covering of the platform, gates and tool trays give them electricity, abrasion and corrosion from most chemical agents resistance property. The surface finishing allows also to prevent slipping.

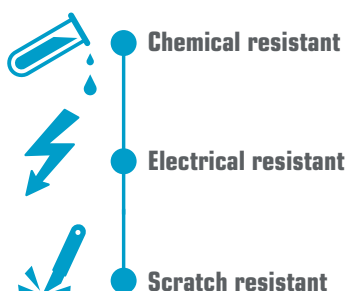

Special Coating

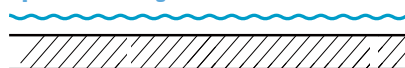

Steel Surface

ELECTRIC VEHICLES MAINTENANCE

La sicurezza sul lavoro è un tema molto importante e rappresenta un fattore determinante di competitività e sviluppo. ISOL8 è il primo e l'unico trattamento superficiale al mondo, studiato in LV8, per poter isolare elettricamente le superfici di lavoro e renderle idonee alla manutenzione dei veicoli elettrici. È possibile ordinare e configurare tutti i nostri arredi con lo speciale trattamento ISOL8.



Work's safety is a very important topic and represents a main factor of competitiveness and development. ISOL8 is the first and only treatment in the world, studied in LV8, in order to electrically isolate the work surfaces and make them suitable for the service of electric vehicles. It's possible to order and configure all our furnishings with the ISOL8 special treatment.



SURFACE TECHNICAL DATA

Lo speciale rivestimento ISOL8 del piano di lavoro fornisce alla superficie resistenza all'elettricità, all'abrasione e corrosione dalla maggior parte di agenti chimici. La finitura superficiale inoltre ne conferisce elevate proprietà antiscivolo.

The ISOL8 special covering of the worktop give it electricity, abrasion and corrosion from most chemical agents resistance property. The surface finishing allows also to prevent slipping.

-  Electrical resistant
-  Chemical resistant
-  Scratch resistant

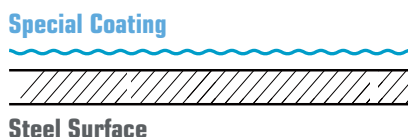

LAVORA IN TUTTA SICUREZZA!
WORK SAFELY!

100%
made in
Lv8
ELEVATE

100%
made in
ITALY



CONCEPT AND REALIZATION OF THE PERFECT AREA TO WORK ON ELECTRIC VEHICLES

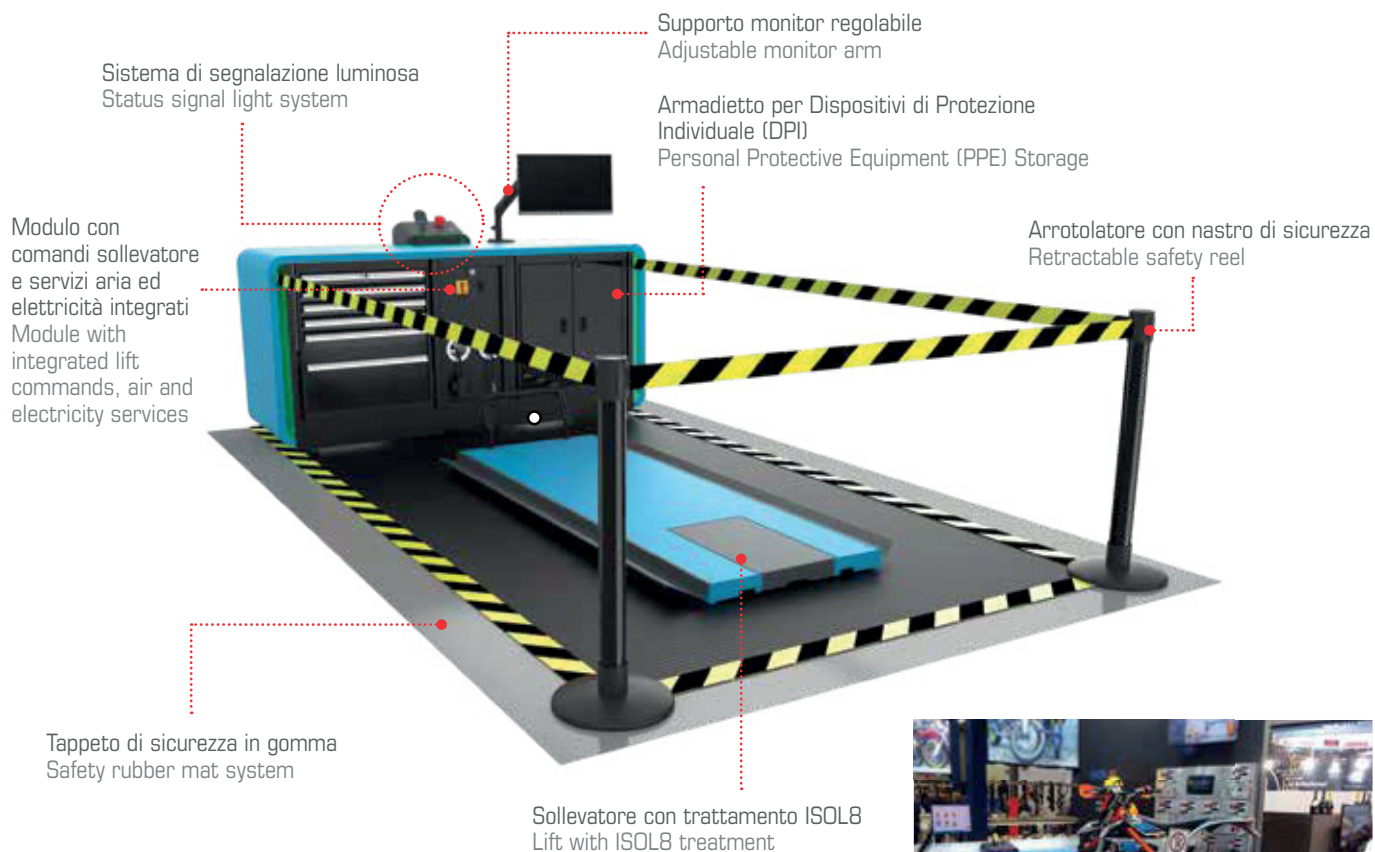

RELATED PRODUCTS



Pannello in acciaio inox per manutenzione batterie
Stainless steel wall panel for battery maintenance



EIG-CBEG00ADRCT

Contenitore con coperchio per la raccolta delle batterie esauste, impilabile e inattaccabile da acidi, grassi e solventi. Dim. cm. 120x80x85h
Container for used batteries, stackable and resistant to acid, grease and oil. Dim. cm. 120x80x85h



Nastro di delimitazione area
Tape for area delimitation

GO TO PAGE ► 61

MOTORCYCLE MANUFACTURERS OFFICIAL COLORS

Ogni sollevatore moto può essere personalizzato secondo le specifiche del cliente o quelle imposte dalle case costruttrici rappresentate. Il nostro ufficio tecnico lavorerà al tuo fianco per amplificare la tua Corporate Identity.

Personalizzazioni cromatiche, grafiche e di intaglio laser rendono i nostri prodotti unici, sinonimo di artigianalità e di stile.

Every motorcycle lifter can be customized according to the customer's specifications or those imposed by the representing manufacturers. Our technical office will work on your side to enhance your Corporate Identity.

Personalized colors, graphics and laser engraving make our products unique, synonymous of craftsmanship and style.



KTM



Customization available for

NANO 400/600

GOLDRAKE 400/600/800

BMW



Customization available for

NANO 400/600

GOLDRAKE 400/600/800

PIAGGIO YAMAHA TRIUMPH



Customization available for

NANO 400/600

GOLDRAKE 400/600/800

KAWASAKI



Customization available for

NANO 400/600

GOLDRAKE 400/600/800

PERSONALIZZAZIONE TAGLIO
LASER A RICHIESTA
LASER CUTTING
PERSONALIZATION ON
REQUEST



HUSQVARNA



Customization
available for

NANO 400/600

GOLDRAKE 400/600/800

ROYAL ENFIELD



Customization
available for

NANO 400/600

GOLDRAKE 400/600/800

DUCATI HONDA



Customization
available for

NANO 400/600

GOLDRAKE 400/600/800

HARLEY



Customization
available for

NANO 400/600

GOLDRAKE 400/600/800

ACCESSORIES

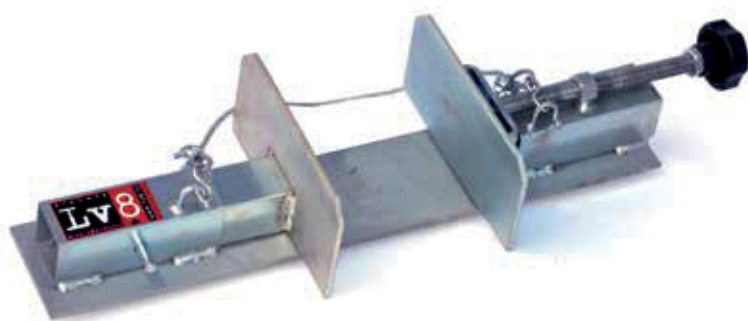

EWCS

Morsa manuale
Manual wheel clamp

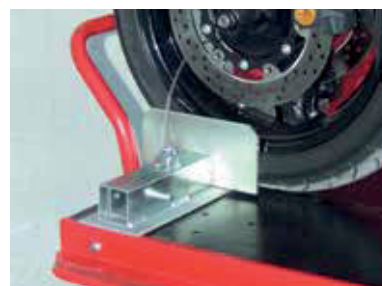

Fori per applicazione presenti su
Goldrake E-Bike, Goldrake 400 e
Nano 400
Holes for application are present on
Goldrake E-Bike, Goldrake 400 e
Nano 400



EWCM

Morsa meccanica
Mechanical wheel clamp



EWCM.QK

KIT sgancio rapido morsa manuale
e pneumatica
QUICK FIX KIT for mechanical and
pneumatic wheel clamp



Utilizzata insieme al cavalletto anteriore LV8 permette di smontare completamente la ruota della moto
 Used together with the LV8 front paddock stand it allows to remove completely the motorcycle wheel



EWCA

Morsa automatica, ideale per sollevatori e anche per il trasporto delle moto nei camion, furgoni e rimorchi.
 Automatic wheel clamp, ideal for lifts and for the motorcycle transportation in your truck, van or trailer as well.

EWCA.QK

KIT sgancio rapido morsa automatica
 QUICK FIX KIT for automatic wheel clamp

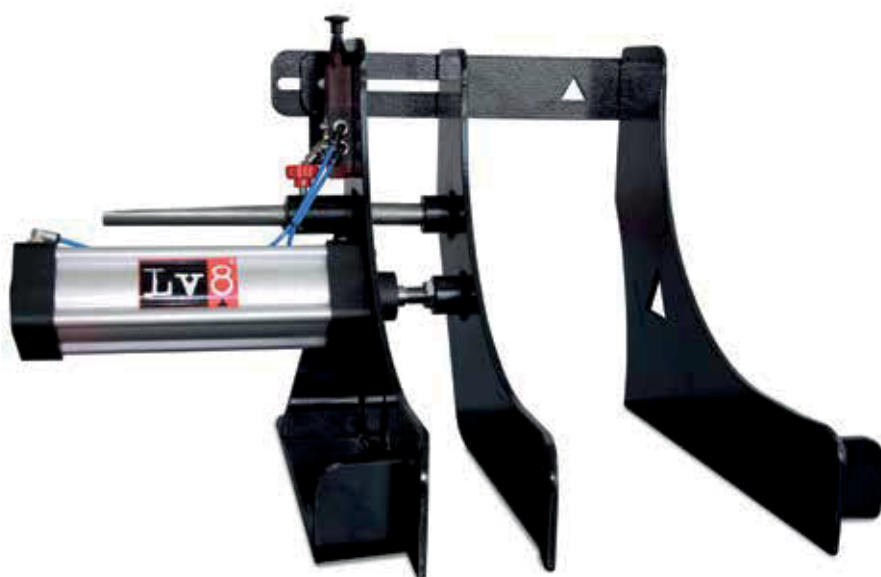

EWCP

Morsa pneumatica
 Pneumatic wheel clamp

EWCP.K

Kit collegamento tubi dell'aria
 Air hose connection kit

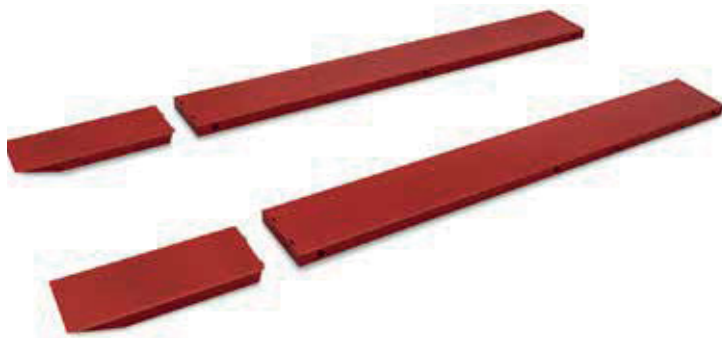

EG600SE

Kit di allargamento per Goldrake 600 (210x27,5cm)
Side extensions kit for Goldrake 600 (210x27,5cm)

EG800SE

Kit di allargamento per Goldrake 800 (220x27,5cm)
Side extensions kit for Goldrake 800 (220x27,5cm)



EN1325-KP4M

Kit estensione tubi da 4 mt per Nano
4 mt pipes extensions kit for Nano

EN1325-KP2M

Kit estensione tubi da 2 mt per Nano
2 mt pipes extensions kit for Nano



EG400TR

Guide per Goldrake 400 (200cm)
Tie rails for Goldrake 400 (200cm)

EG600TR

Guide per Goldrake 600 (210cm)
Tie rails for Goldrake 600 (210cm)

EG800TR

Guide per Goldrake 800 (220cm)
Tie rails for Goldrake 800 (220cm)

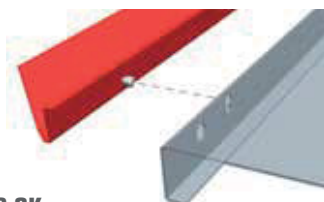

EG400.QK

Kit attacchi rapidi per alette porta utensili
Quick fix kit tool holders goldrake

EG600SE.QK

Kit attacchi rapidi estensioni laterali goldrake
Quick fix kit side extension goldrake



EIE-LTPNK01

Kit radiocomando
Remote control kit



EAP-ALL

Lamiera alluminio antiscivolo per Nano e Goldrake 400/600/800 (54x34cm)
Antiskid aluminium platform for Nano and Goldrake 400/600/800 (54x34cm)

EAP-ALLJ

Lamiera alluminio antiscivolo per Goldrake E-Bike (50x31,5cm)
Antiskid aluminium platform for Goldrake E-Bike (50x31,5cm)



EIE.K2PG

Comando a pedale optional
Pedal control



ERA20

Adattatori in gomma (140x120x20mm)
Rubber adapters (140x120x20mm)



ERA40

Adattatori in gomma (160x120x40mm)
Rubber adapters (160x120x40mm)



ERA60

Adattatori in gomma (160x120x60 mm)
Rubber adapters (160x120x60 mm)

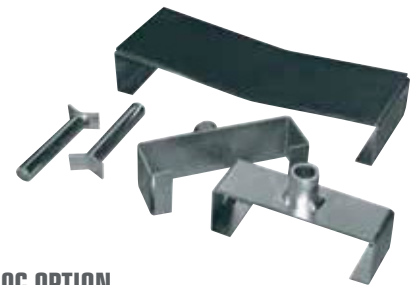

E500C

E500C.OPTION

Cavalletto centrale a vite sotto culla per Custom, Harley Davidson, Enduro, Cross, Scooter
 Central Jack under cradle for Custom, Harley Davidson, Enduro, Cross, Scooter

Kit supporti regolabili optional, solo per E500C
 Optional adjustable supports kit, only for E500C

Caratteristiche tecniche

- Altezza minima: 90mm
- Altezza massima: 310mm
- Capacità: 350kg
- Spostamento verticale del carico: 220mm
- Altezza colonne: 130mm
- Dimensioni ingombro: 510x210x170mm
- Peso: 18kg

Technical Features

- Minimum height: 90mm
- Maximum height: 310mm
- Capacity: 350kg
- Lifting height: 220mm
- Columns height: 130mm
- Dimensions: 510x210x170mm
- Weight: 18kg



E500C.L

Cavalletto centrale a vite sotto culla largo
 Large central Jack under cradle

Caratteristiche tecniche

- Altezza minima: 90mm
- Altezza massima: 370mm
- Capacità: 350kg
- Spostamento verticale del carico: 280mm
- Dimensioni ingombro: 510x300x90mm
- Peso: 28kg

Technical Features

- Minimum height: 90mm
- Maximum height: 370mm
- Capacity: 350kg
- Lifting height: 280mm
- Dimensions: 510x300x90mm
- Weight: 28kg

WORKSHOP MODULAR FURNITURE



MADE IN ITALY

Interamente progettati, costruiti e premontati all'interno della nostra Azienda gli arredamenti LVB vengono prodotti e assemblati con componenti 100% Made In Italy per garantire massima affidabilità, qualità, durata nel tempo e sicurezza.

ERGONOMIA

Gli arredi LVB si differenziano per le loro caratteristiche dimensionali e tecniche, frutto di anni di esperienza nella progettazione e sviluppo di soluzioni per il settore Automotive. In officina le misure antropometriche sono di fondamentale importanza per poter operare in maniera fluida e veloce, pulita ed organizzata e rendere efficiente e produttivo il proprio lavoro.

MADE IN ITALY

Entirely designed, produced and pre-assembled in our firm, LVB furniture modules are manufactured and put together with 100% Made in Italy components so as to guarantee the best reliability, quality, durability and safety.

ERGONOMICS

LVB furniture is characterized by its dimensional and technical peculiarities, resulted from years and years of experience in the design and development of solutions for the automotive sector. In a workshop, anthropometric measures are extremely important in order to work in a fast, fluid, clean and organized manner and so as to make one's work efficient and productive.

La linea di arredo per officina LV8 è composta da una vasta gamma di moduli e complementi per soddisfare le necessità funzionali e le normative delle più moderne officine.

Componibile ed estremamente versatile l'arredo LV8 si presta ad essere utilizzato in svariati settori quali Automotive, Motorcycle, Motorsport, Industria. Avere uno spazio perfettamente organizzato è il primo passo verso un ambiente di lavoro ordinato, efficiente e produttivo. Il nostro servizio di consulenza e progettazione permette di fornire soluzioni Custom Made per razionalizzare e ottimizzare ogni ambiente di lavoro allestendo anche spazi particolari, angusti o dalle dimensioni fuori standard.

Gli arredi LV8 permettono inoltre di ricreare e comunicare un'atmosfera adatta al tuo stile e alla tua personalità in linea con la Brand Identity delle Case Costruttrici.

LV8 line of workshop furniture encompasses a large range of modules and accessories aimed at meeting the functional necessities and standards of the most modern workshops.

Thanks to its being modular and extremely versatile, LV8 furniture is suitable for being used in several sectors, such as automotive, motorcycle, motorsport or, more generally, manufacturing. Having a perfectly organized physical environment is the first step towards an orderly, efficient and productive workplace.

Our design and advisory service allows to offer custom made solutions to rationalize and optimize every working environment, by means of setting up even particular, restricted spaces or with non-standard dimensions.

In addition to that, LV8 furniture permits to recreate and convey an atmosphere suitable for your style and your personality in harmony with the Brand Identity of the Manufacturers.

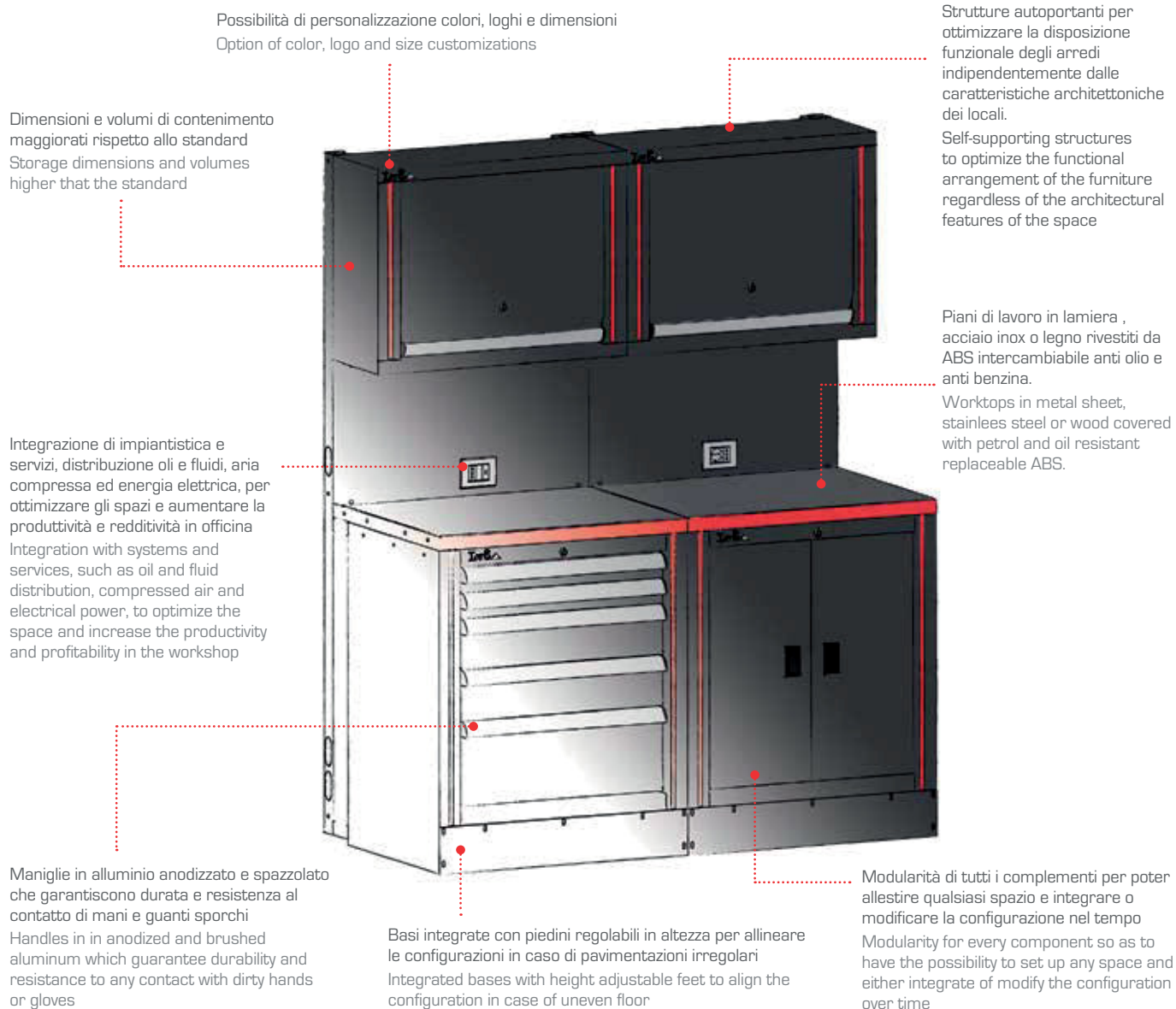

Possibilità di personalizzazione colori, loghi e dimensioni
Option of color, logo and size customizations

Dimensioni e volumi di contenimento maggiorati rispetto allo standard
Storage dimensions and volumes higher than the standard

Strutture autoportanti per ottimizzare la disposizione funzionale degli arredi indipendentemente dalle caratteristiche architettoniche dei locali.
Self-supporting structures to optimize the functional arrangement of the furniture regardless of the architectural features of the space

Integrazione di impiantistica e servizi, distribuzione oli e fluidi, aria compressa ed energia elettrica, per ottimizzare gli spazi e aumentare la produttività e redditività in officina
Integration with systems and services, such as oil and fluid distribution, compressed air and electrical power, to optimize the space and increase the productivity and profitability in the workshop

Piani di lavoro in lamiera, acciaio inox o legno rivestiti da ABS intercambiabile anti olio e anti benzina.
Worktops in metal sheet, stainless steel or wood covered with petrol and oil resistant replaceable ABS.

Maniglie in alluminio anodizzato e spazzolato che garantiscono durata e resistenza al contatto di mani e guanti sporchi
Handles in anodized and brushed aluminum which guarantee durability and resistance to any contact with dirty hands or gloves

Basi integrate con piedini regolabili in altezza per allineare le configurazioni in caso di pavimentazioni irregolari
Integrated bases with height adjustable feet to align the configuration in case of uneven floor

Modularità di tutti i complementi per poter allestire qualsiasi spazio e integrare o modificare la configurazione nel tempo
Modularity for every component so as to have the possibility to set up any space and either integrate or modify the configuration over time

PERSONALIZZAZIONE

Proponiamo banchi di lavoro, carrelli, armadi e complementi con possibilità di personalizzazione colore. Su richiesta è inoltre possibile realizzare soluzioni uniche e tailor made con personalizzazioni estetiche e dimensionali per poter adattarsi ai vincoli architettonici dei locali e rispettare le diverse Corporate Identity dei brand.

MONTAGGIO PRE-CONSEGNA

Il premontaggio in Azienda di ogni configurazione di arredo è fondamentale prima della spedizione per verificare che le parti tailor made siano dimensionalmente, tecnicamente ed esteticamente conformi alle richieste del cliente e agevolarne il posizionamento nei locali dopo la consegna.

CUSTOMIZATION

We offer workbenches, trolleys, closets and accessories with the option of customizing them with the color of your choosing. In addition to that, it is also possible, upon request, to implement unique and tailor-made solutions with aesthetic and dimensional customizations so that the modules can match and adapt to your place's architectural constraints and respect the different brands' Corporate Identities.

ASSEMBLY BEFORE DELIVERY

The pre-assembly in the firm of every furniture configuration is fundamental before shipping it, so that we can make sure that the tailor-made parts are in compliance in dimensional, technical and aesthetic terms with the client's demands and therefore facilitate their placement in the workshop after the delivery.

WORKSHOP ARCHITECTURE



Scarica il catalogo tecnico dedicato all'arredo Qube®
Download the technical catalogue dedicated to the Qube® furniture

QUBE® è progettazione, studio e realizzazione di interni d'officina. Grazie ad un'ampia gamma di moduli e complementi 100% made in Italy, interamente progettati e costruiti in LVB®, è possibile strutturare e realizzare soluzioni personalizzate di arredo, integrabili con le specifiche attrezzature di lavoro e gli impianti per la distribuzione aria, fluidi e gas di scarico.

I nostri consulenti analizzano le richieste della clientela creando ambienti dai dettagli sartoriali in linea con il budget della clientela e gli standard estetici e qualitativi richiesti dalla Case Costruttrici.

Il servizio completo di progettazione comprende studi e preventivi

preliminari, rilievi misure e consulenza di interni con l'obiettivo di riorganizzare lo spazio e contemporaneamente definire un profilo di stile unico e originale. Proponiamo vari livelli di visualizzazione dei nostri progetti sia in 2d che in 3d, dalle planimetrie e tavole tecniche ai render tridimensionali a colori.

Ci occupiamo di nuovi spazi, ma anche di progetti di relooking per rinnovare e migliorare l'aspetto, l'ergonomia e l'efficienza dei singoli ambienti d'officina senza i costi di una ristrutturazione tradizionale poiché non sono necessarie modifiche ad impianti e murature. Scopri i nostri servizi e richiedi la consulenza dei nostri esperti per un progetto e preventivo gratuiti.



9047,5

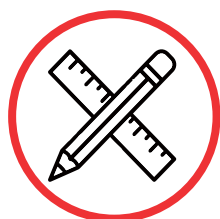

**PROGETTAZIONE
DESIGN**

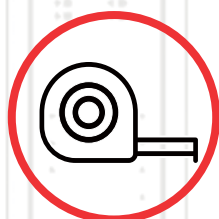

**PERSONALIZZAZIONE
TAILOR MADE**



**CONSULENZA FINANZIARIA
FINANCIAL ADVICE**

QUBE® is design, study and realization of workshop interiors. Thanks to a wide range of cabinets and accessories 100% Made in Italy, entirely designed and produced in LV8®, it is possible to compose and create customized furniture solutions, which can be integrated with the specific workshop equipment and the air distribution systems, fluids and exhaust gas extraction. Our consultants analyse the customer requests by creating environments with tailored details in line with the client's budget and the aesthetic and quality standards required by the Motorcycles Companies. The complete design service includes preliminary studies and

quotations, measurements and consultancy with the goal of reorganize the space and simultaneously define a unique and original style profile. We propose various ways to browse our projects both in 2D and 3D, from the floorplan and technical drawing to the three-dimensional colour renderings. We take care of new areas, but also of relooking projects to renovate and improve the aesthetic, ergonomics and efficiency of every workshop environments without the costs of a traditional renovation since changes to systems and walls are not necessary. Check out our services and request the advice of one of our experts for a free project and quotation.



SOLLEVATORI MOTO
MOTORBIKE LIFTS



SOLLEVATORI AUTO
CAR LIFTS



ARREDO
FURNITURE



IMPIANTI OLIO
FLUIDS DISTRIBUTION
SYSTEMS



IMPIANTI ARIA
AIR DISTRIBUTION
SYSTEMS



IMPIANTI ASPIRAZIONE
GAS DI SCARICO
EXHAUST EXTRACTION
SYSTEMS



PRODUZIONE
PRODUCTION



INSTALLAZIONE
INSTALLATION



SUPPORTO POST VENDITA
CUSTOMER CARE

STEP 1

Planimetria , sopralluogo tecnico e condivisione del brief
Floor plan, technical inspection and briefing



STEP 2

Sviluppo progetto e realizzazione tavola tecnica in 2D
Project development and 2D drawing realization

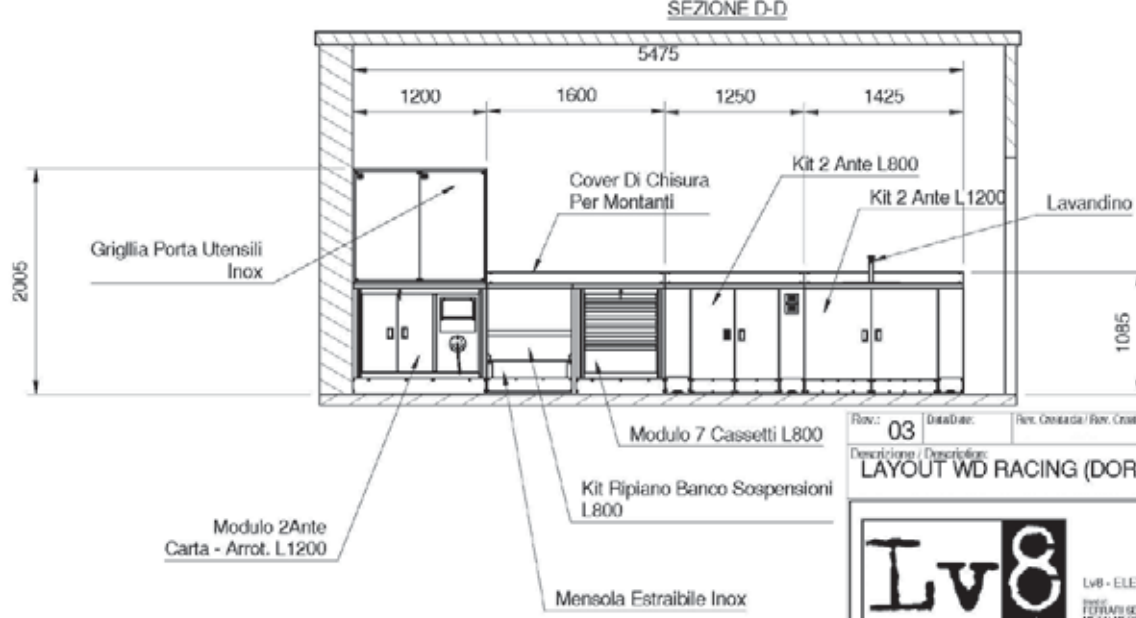
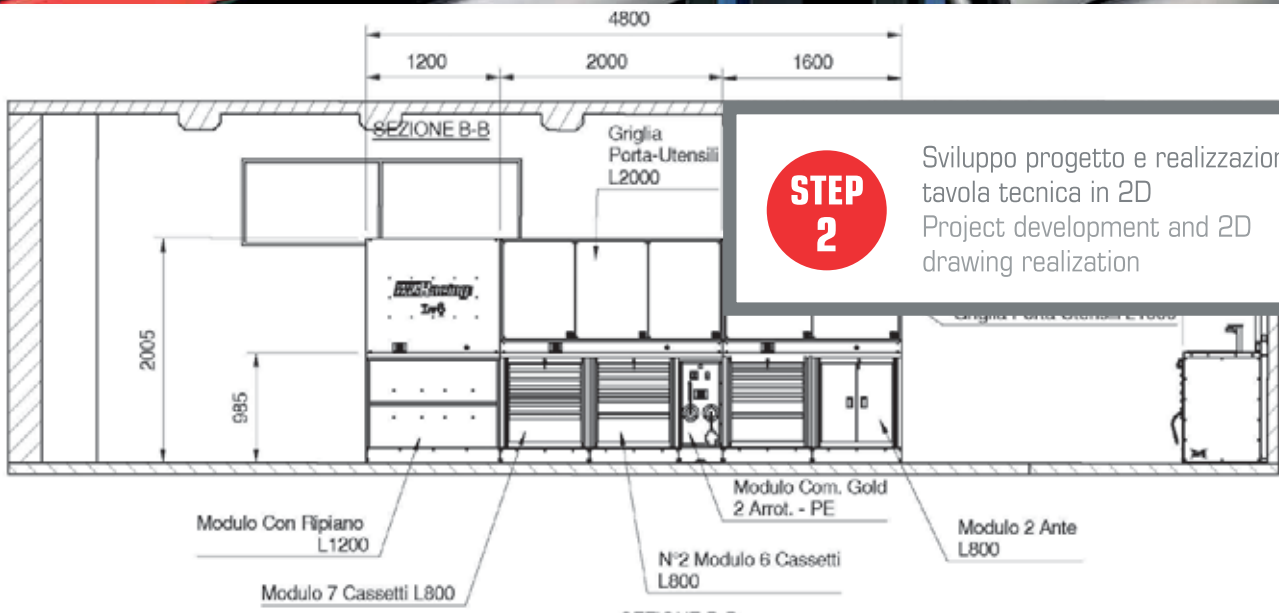

Rev: 03 Data: Rev. Created by: Descrizione / Description: Aggiornamento

Descrizione / Description: **LAYOUT WD RACING (DORNO)**

Tolleranza Generale / General Tolerance:	risa / range
Materiale / Material:	Stato / Pa
Trattamento / Treatment:	Crosto da
Code / Code:	

Lv8 - ELEVATE
S.p.A. - VIA S. GIUSEPPE 10
37060 - VERONA (VR) - ITALIA

Il presente disegno non può essere usato pubblicamente e sottoposto senza autorizzazione scritta della Tecnica Fregio Meccanica S.p.A.



**STEP
3**

Realizzazione rendering in 3D e
definizione progetto
3D drawing realization and
project definition

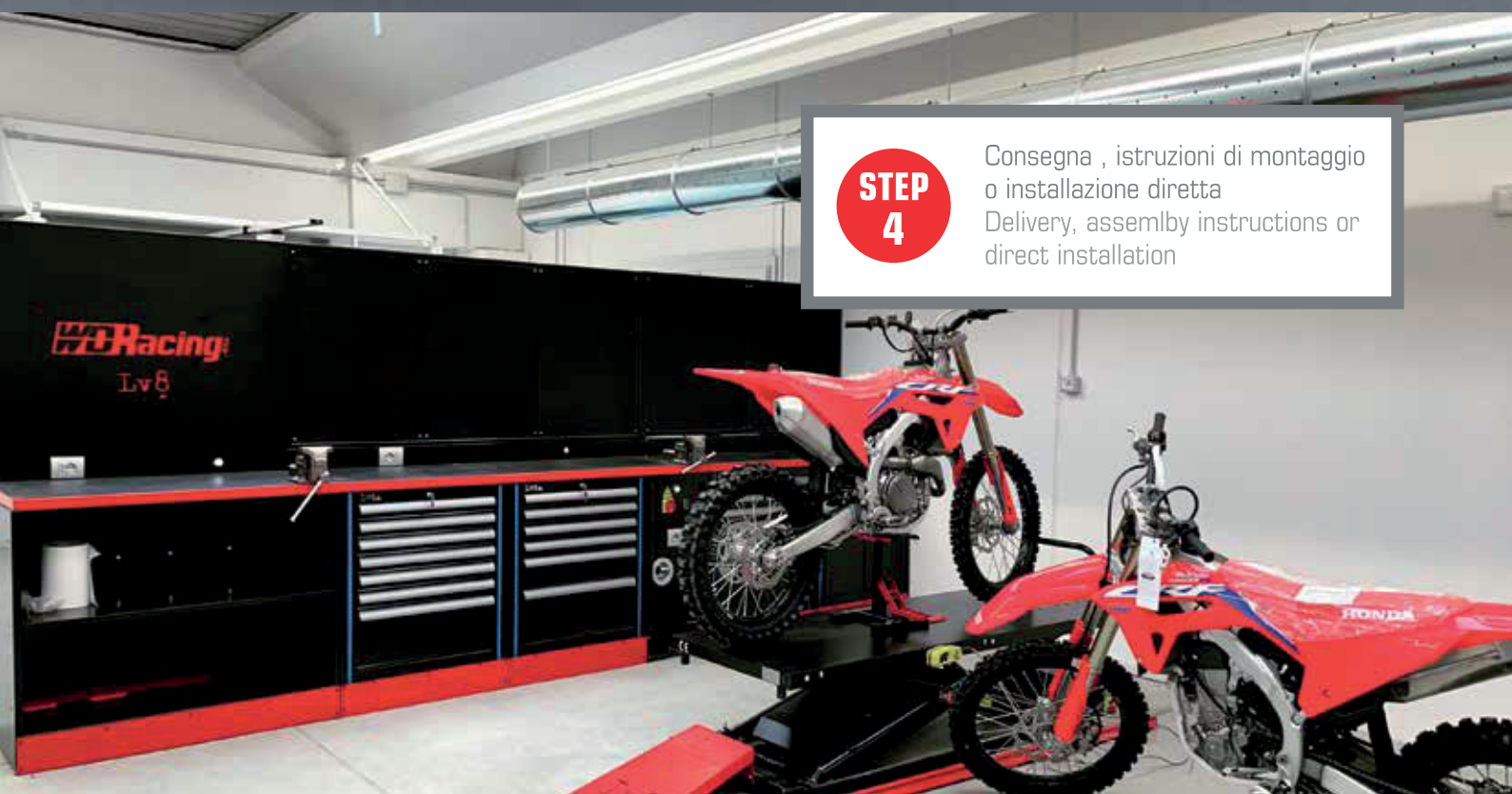

**STEP
4**

Consegna , istruzioni di montaggio
o installazione diretta
Delivery, assembly instructions or
direct installation

INVIACI LA PLANIMETRIA DELLA TUA OFFICINA!

Per ricevere un progetto gratuito e
offrire leggi il QR Code, compila il
modulo e allega la tua planimetria.

SEND US YOUR WORKSHOP FLOOR PLAN!

In order to receive a free project and
offer read the QR Code, fill the form
and attach your workshop floor plan.



CONFIGURATIONS

Soluzioni di arredo LV8® preconfigurate, 100% made in LV8®, sviluppate con l'intento di soddisfare le esigenze del mercato attraverso soluzioni standard sempre disponibili a magazzino.

Le principali caratteristiche:

- 100% made in Italy
- Dimensioni standard
- Personalizzazione colore
- Consegna veloce

I nostri banchi preconfigurati sono sempre integrabili e convertibili all'interno di un progetto QUBE® a misura.

Pre-configured LV8® furniture solutions, 100% made in LV8®, developed in order to satisfy the market needs through standard solutions always in stock.

The main features:

- 100% made in Italy
- Standard dimensions
- Color customization
- Fast delivery

Our pre-configured workbenches can be always integrated and converted within a tailor made QUBE® project.



COMPONI IL TUO BANCO DI LAVORO! COMPOSE YOUR WORKBENCH!

STEP 1

Scegli la dimensione del banco: 1600 oppure 2000 mm
Choose the workbench dimension: 1600 or 2000 mm

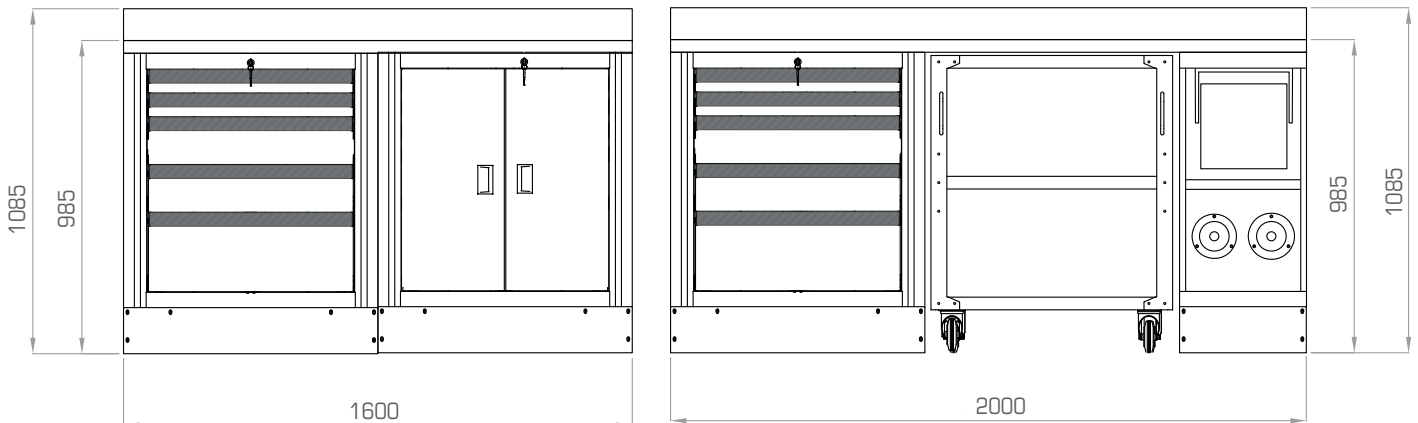

STEP 2

Seleziona la configurazione che preferisci
Choose your favorite configuration

1600



GO TO PAGE ► 42

2000



GO TO PAGE ► 43

STEP 3

Integra la tua configurazione aggiungendo la parte superiore
Integrate your configuration adding the upper part

Solo per banco da 1600 mm
For 1600 mm workbench only



EQP16-KIT

Kit 2 pensili L. 800 mm cad., tamponamento e struttura autoportante
2 wall cabinet 800 mm each, bottom closing panel and self-supporting kit

Solo per banco da 2000 mm
For 2000 mm workbench only



EQPU20-KIT

Kit griglia portautensili L. 2000 mm e struttura autoportante
Tools holder grid L. 2000 mm and self-supporting kit

Solo per banco da 2000 mm
For 2000 mm workbench only



EQAT20-KIT

Kit porta utensili a muro L. 2000 mm con serranda in alluminio e struttura autoportante
Tools holder wall panel L. 2000 mm with aluminum shutter and self-supporting kit

STEP 4

Scegli il tuo colore preferito tra quelli disponibili per piana e strisce verticali
Choose your favorite color among those available for the top and the vertical stripes

Moduli sempre neri RAL 9005 standard
Modules always black ral 9005 standard

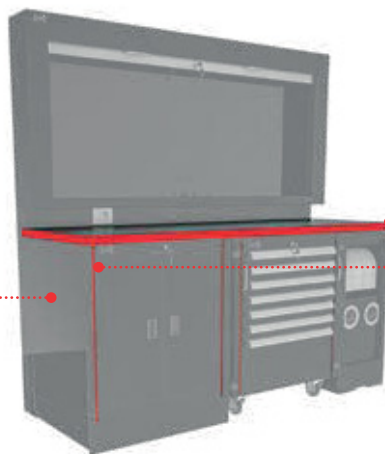

- R** RED RAL 3002
- B** BLUE RAL 5005
- O** ORANGE RAL 2009
- Y** YELLOW RAL 1021
- G** GREEN RAL 6018
- W** WHITE RAL 9016

STEP 5

Aggiungi gli accessori
Add the accessories



EQAC-AR10

Arrotolatore aria con uscita M1/4"
Air hose reel with M1/4" exit



EQAC-ER10

Arrotolatore corrente 220V 1600W con 3 prese shuko
Electric cable reel 220V 1600W with 3 shuko sockets



EQAT1G-KG01

Kit ganci per utensili vari 100pz.
In FE zincato con tassello a vite
100pz. hooks in galvanised steel



Assortimenti di utensili in termoformato soft
Soft thermoformed trays with tools assortments

GO TO PAGE ► 94-95

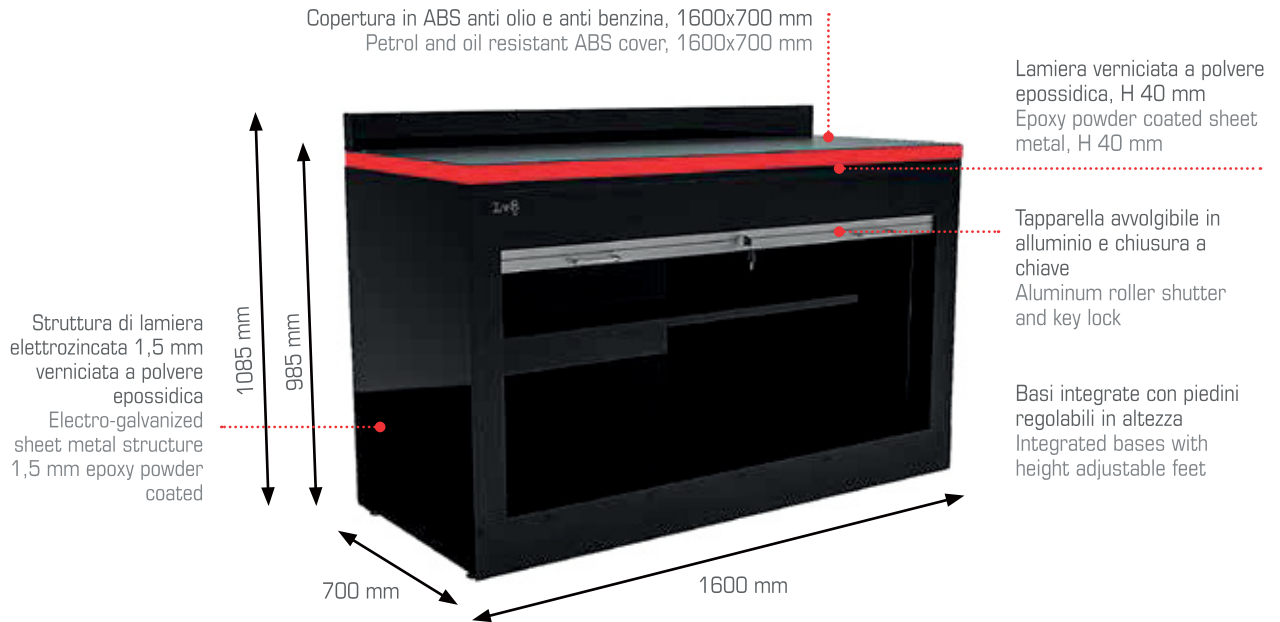

EQS16-01

Banco L.1600 mm con ripiano, tapparella avvolgibile in alluminio e chiusura a chiave, tamponamento H.100 mm, piana e copertura in ABS anti olio e anti benzina.

L.1600 mm Workbench with L 1600mm Cabinet with roller shutter; key lock and inside shelf, H 100mm Blind bottom closing panel, Worktop and Anti-Petrol and Anti-Oil ABS Worktop cover.



EQS16-02

Banco L.1600 mm con cassettera fissa a 5 cassette L.800 mm, modulo a 2 ante L.800 mm con ripiano interno e chiusura a chiave, tamponamento H 100 mm, piana e copertura in ABS anti olio e anti benzina.

L 1600 mm Workbench with L 800 mm Cabinet with 5 drawers, L 800mm Cabinet with 2 doors, key lock and adjustable inside shelf, H 100mm Blind bottom closing panel, Worktop and Anti-Petrol and Anti-Oil ABS Worktop cover.

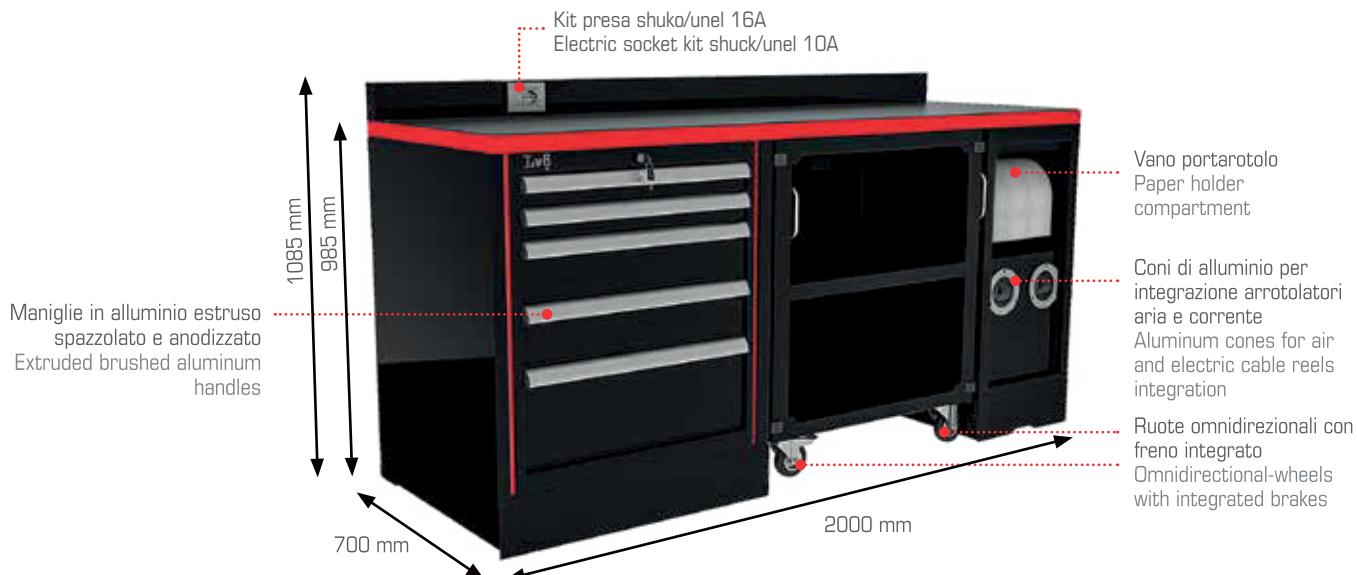

EQS20-01

Banco L.2000 mm con ripiano L.1600 mm tapparella avvolgibile in alluminio e chiusura a chiave, tamponamento H.100 mm con presa, piana e copertura in ABS anti olio e anti benzina.

L 2000mm Workbench with L 1600mm Cabinet with roller shutter; key lock and inside shelf, L 400mm Cabinet with predisposition for 2 hose reels and paper holder compartment, H 100mm Bottom closing panel with electric socket, Worktop and Anti-Petrol and Anti-Oil ABS Worktop cover.



EQS20-02

Banco L.2000 mm con cassettera fissa a 5 cassetti L.800mm, carrello a 3 ripiani sottopiana, modulo L.400mm con predisposizione per 2 arrotolatori e vano portarotolo, tamponamento H.100 mm con presa, piana e copertura in ABS anti olio e anti benzina.

L 2000mm Workbench with L 800mm Cabinet with 5 drawers, L 800mm Under table trolley 3 shelves, L 400mm Cabinet with predisposition for 2 hose reels and paper holder compartment, H 100mm Bottom closing panel with electric socket, Worktop and Anti-Petrol and Anti-Oil ABS Worktop cover.



EQS20-03

Banco L.2000 mm con modulo 2 ante 800 mm, carrello 7 cassetti, modulo L.400 mm con predisposizione per 2 arrotolatori e vano portarotolo, tamponamento H.100 mm con presa, piana e copertura in ABS anti olio e anti benzina.

L 2000mm Workbench with L 800mm Cabinet with 2 doors, L 800mm Under table trolley with 7 drawers, L 400mm Cabinet with predisposition for 2 hose reels and paper holder compartment, H 100mm Bottom closing panel with electric socket, Worktop and Anti-Petrol and Anti-Oil ABS Worktop cover.

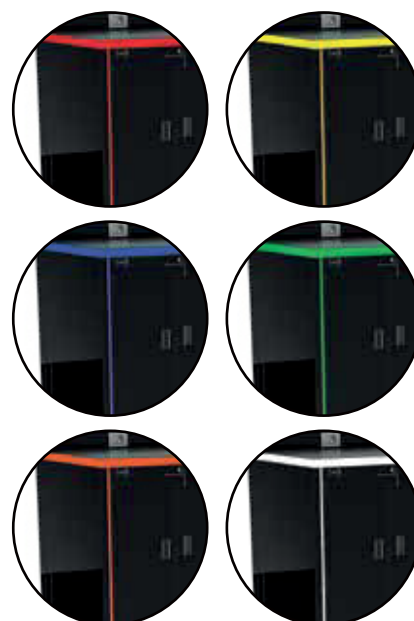

Pannello personalizzabile con loghi e grafiche
Customizable panel with logotypes and graphics

Montanti in tubolare di acciaio 80x80
Column in tubular steel 80x80

SCEGLI IL COLORE
CHOOSE THE COLOR



Piedi a semicerchio grazie ai quali è possibile affiancare più paretine e ottenere soluzioni lineari o angolari
Semi-circular feet thanks to which it's possible to combine the partitions and obtain linear and corner solutions

EQPM01

Paretina mobile divisoria L. 1600 mm
Movable partition wall L. 1600 mm

EQPM02

Paretina mobile divisoria L. 1200 mm
Movable partition wall L. 1200 mm

Fornita montata
Peso 50 kg
Supplied assembled
Weight 50 kgs

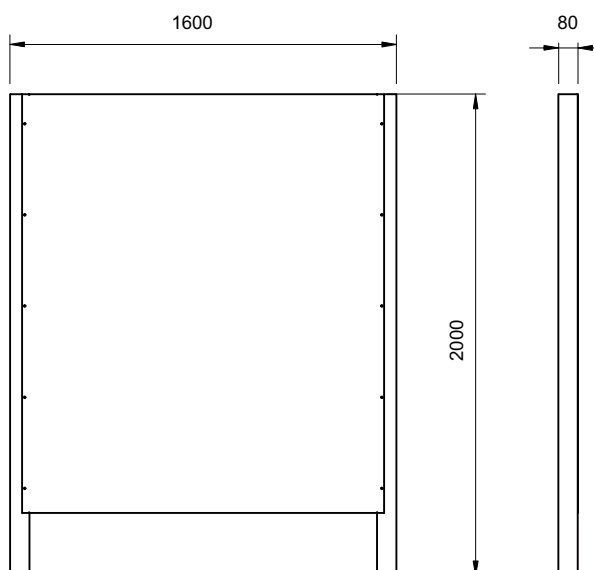

Portata per ripiano 100 kg
Load capacity per shelf: 100 kgs

Ripiani regolabili in altezza
Height adjustable shelves



Struttura autoportante in lamiera
elettrozincata sp. 20/10
Self-supporting structure in electro-
galvanized sheet steel d. 20/10

Ripiani personalizzabili nei colori
Customizable shelves available in
the colors

SCEGLI IL COLORE
CHOOSE THE COLOR



EQSC0807

Scaffale a 4 ripiani
n°4 shelf module
H2000 L800 P700

EQSC1207

Scaffale a 4 ripiani
n°4 shelf module
H2000 L1200 P700

EQSC1607

Scaffale a 4 ripiani
n°4 shelf module
H2000 L1600 P700

EQSC2007

Scaffale a 4 ripiani
n°4 shelf module
H2000 L2000 P700

Consegnato con istruzioni di montaggio
Peso 60 -100 kg a seconda delle dimensioni
Supplied with assembly instructions
Weight 60-100 kgs depending on the size

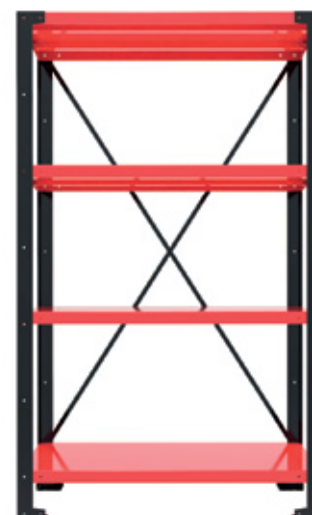
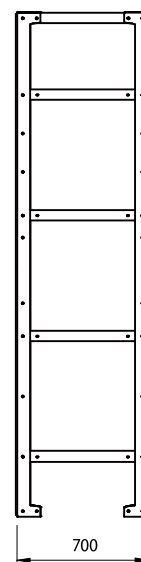
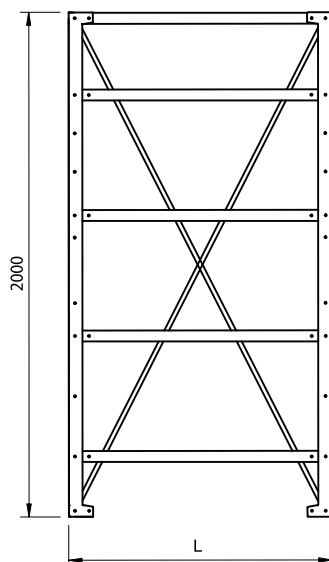



EQA2A

Armadio a 2 ante con chiusura a chiave e 4 ripiani regolabili
 2 doors closet with key lock and 4 adjustable shelves

Fornito montato
 Peso 100 kg
 Supplied assembled
 Weight 100 kgs

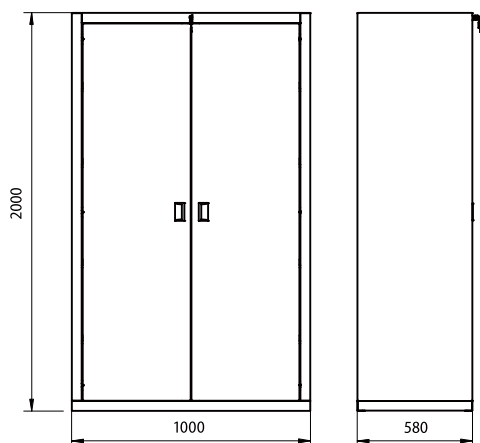



Scorrimento su guide ad alta portata e ruote industriali diam. 60 mm
Sliding on high capacity slides and industrial wheels diam. 60 mm

3 cassettoni, ognuno con doppia griglia completamente estraibili
3 big drawers, each with double grid, completely extractable

6 griglie in totale = 8 mq di griglie portautensili in meno di 1 metro!
6 grids in total = 8 sqm of tools holders grids in less than 1 metre!

SCEGLI IL COLORE
CHOOSE THE COLOR



EQAF01

Armadio a 3 cassetti verticali ad estrazione guidata con doppie griglie forate portautensili
Closet with 3 vertical drawers by sliding extraction with double tool grids

Fornito montato
Peso: 180 kg
Supplied assembled
Weight 180 kgs

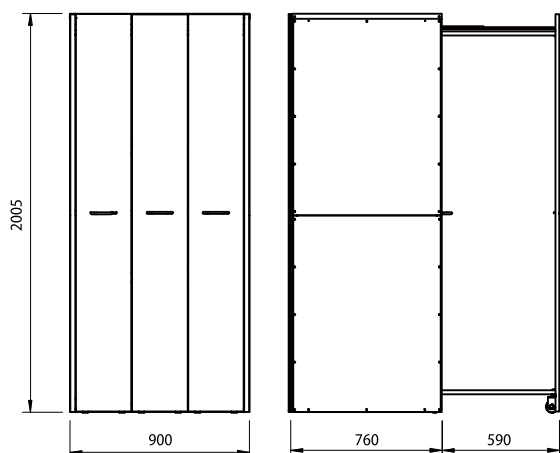

EQAT1G-KG01



Kit ganci per utensili vari 100pz.
In FE zincato con tassello a vite 100pz. hooks in galvanised steel



Può ospitare almeno 8 taniche da 20 lt cad e 2 fusti da 60 lt cad.
It can house at least 8 tanks of 20 lt each and 2 drums of 60 lt each

Ripiani scorrevoli e regolabili in altezza
Sliding and height adjustable shelves

Lamiera elettrozincata sp. 20/10 verniciata a polvere epossidica
Electro-galvanized sheet steel d. 20/10 painted with epoxy powder

SCEGLI IL COLORE
CHOOSE THE COLOR



Cerniere in acciaio ad alta resistenza
High strength steel hinges

Struttura solida in corpo unico senza pezzi ad incastro
Solid unibody structure without interlocking elements



EQA03R

Armadio stoccaggio oli a due ante, dotato di chiusura a chiave, 3 ripiani scorrevoli e regolabili in altezza, vasca di raccolta olio e fori di aerazione per il ricircolo dell'aria.
Closet for oil storage equipped with key lock, 3 sliding and height adjustable shelves, oil collection tank and ventilation holes for air circulation

Fornito montato
Peso 750 kg
Supplied assembled
Weight 750 kgs

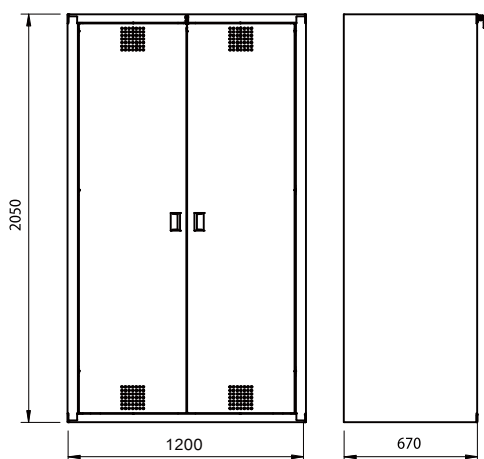

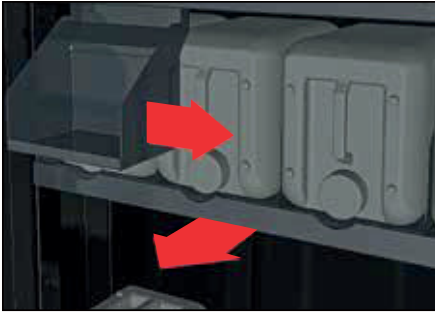

RIPIANI ESTRAIBILI
 Ripiani scorrevoli su cuscinetti ad altezza regolabile dotati di divisori
REMOVABLE SHELVES
 Sliding shelves on bearings with adjustable height and dividers



VASCA DI RACCOLTA
 Vasca di raccolta olio capacità max 80 Lt in acciaio inox, saldata e con griglia removibile
COLLECTION TANK
 Stainless steel oil collection tank max capacity 80 Lt, welded and with removable grid



FORI AERAZIONE
 Fori di aerazione per il ricircolo dell'aria sul retro e sulle ante dell'armadio
VENTILATION HOLES
 Ventilation holes for air circulation on the back and on the doors of the closet



RELATED PRODUCTS



EI-PF60.202

Pompa manuale con pescante telescopico per fusti 60-202 Lt
 Manual pump for drums with telescopic suction tube 60-202 Lt



EIO-EKON101Z

Vasca portafusti (1 fusto)
 Drums container (1 drum)

EIO-EKON102Z

Vasca portafusti (2 fusti)
 Drums container (2 drums)

EIO-EKON104Z

Vasca portafusti (4 fusti)
 Drums container (4 drums)



EIO-ECOIL260N

Campana per raccolta e stoccaggio olio esausto 300 lt
 Exhaust oil recovery and stocking tank 300 lt

EIO-ECOIL500N

Campana per raccolta e stoccaggio olio esausto 500 lt
 Exhaust oil recovery and stocking tank 500 lt

Piano in legno multistrato verniciato,
impermeabile e antiolio
Plywood painted, waterproof and
oil-resistant worktop

Lamiera elettrozincata
sp. 10/10 verniciata a
polvere epossidica
Electro-galvanized sheet
steel d. 10/10 painted
with epoxy powder

Guide ad alta portata
High capacity slides

Paracolpi laterali per
evitare urti
Side bumpers to avoid
damages



Cassetti ad estrazione totale
Fully extractable drawers

Maniglie cassetti in alluminio
estruso spazzolato e anodizzato
Extruded brushed aluminium
handles

**SCEGLI IL COLORE
CHOOSE THE COLOR**



Ruote industriali specifiche per carichi pesanti (4 pivotanti per
permettere la guida frontalmente e lateralmente)
Industrial wheels for heavy loads (4 pivoting to allow the front
and lateral guide)

EQM7K.7605

Carrello 7 cassetti integrato con
piano di lavoro in legno antiolio.
L. 800 mm
Integrated under table 7 drawer
trolley with oil-resistant wooden
worktop. L. 800 mm

Fornito montato
Peso 70 kg
Supplied assembled
Weight 70 kgs



75 mm	50 kg
75 mm	50 kg
75 mm	50 kg
75 mm	50 kg
75 mm	50 kg
75 mm	50 kg
250 mm	50 kg

EQM5K.1105

Carrello 5 cassetti integrato con
piano di lavoro in legno antiolio.
L. 1200 mm
Integrated under table 5 drawer
trolley with oil-resistant wooden
worktop. L. 1200 mm

Fornito montato
Peso 90 kg
Supplied assembled
Weight 90 kgs



75 mm	50 kg
75 mm	50 kg
150 mm	50 kg
150 mm	50 kg
250 mm	50 kg

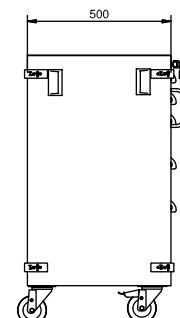
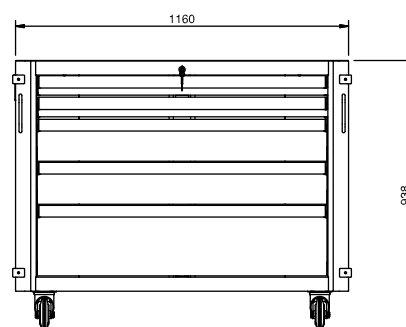
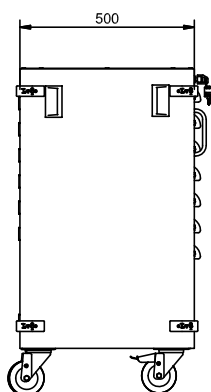
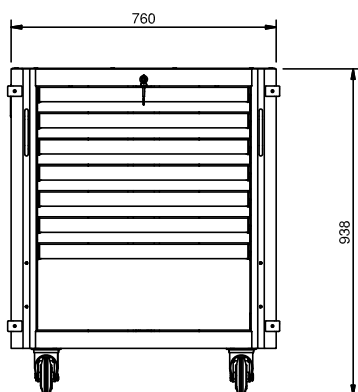

Lamiera elettrozincata sp. 10/10 verniciata a polvere epossidica
Electro-galvanized sheet steel d. 10/10 painted with epoxy powder

Paracolpi laterali
per evitare urti
Side bumpers to
avoid any clash

2 Maniglie frontali in alluminio e
2 maniglie posteriori in plastica
a scomparsa per semplici
manovre di spostamento
2 retractable front aluminum
handles and 2 retractable
rear plastic handles for simple
moving operations

3 Ripiani con bordo laterale
rialzato, portata 60 kg cad.
Shelves with raised and lateral
edge, capacity 60 kg each

Ruote industriali ad alta portata
specifiche per carichi pesanti
(4 pivotanti per permettere la guida
frontalmente e lateralmente)
Industrial wheels with high capacity for
heavy loads (4 pivoting to allow the front
and lateral guide)

Integrabile sotto i nostri banchi di lavoro
e reversibile: la schiena posteriore
nasconde il materiale in esso contenuto.
It can be integrated under our
workbenches and it is reversible: the
back panel hides the material inside

Ripiano intermedio regolabile
Adjustable intermediate shelf

SCEGLI IL COLORE
CHOOSE THE COLOR



EQC3RS.7605

CARRELLO A 3 RIPIANI L.800 mm
TROLLEY WITH 3 SHELVES L.800 mm

Fornito smontato con istruzioni di montaggio
Peso 30 Kg

Supplied disassembled with assembly instructions
Weight 30 kgs

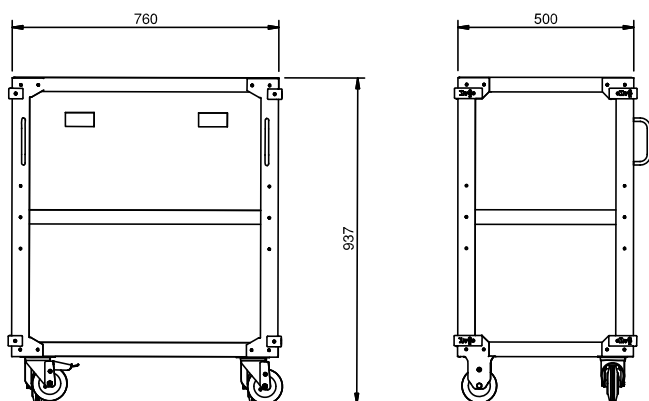

EQC3RS.1105

CARRELLO A 3 RIPIANI L.1200 mm
TROLLEY WITH 3 SHELVES L.1200mm

Fornito smontato con istruzioni di montaggio
Peso 40 Kg

Supplied disassembled with assembly instructions
Weight 40 kgs

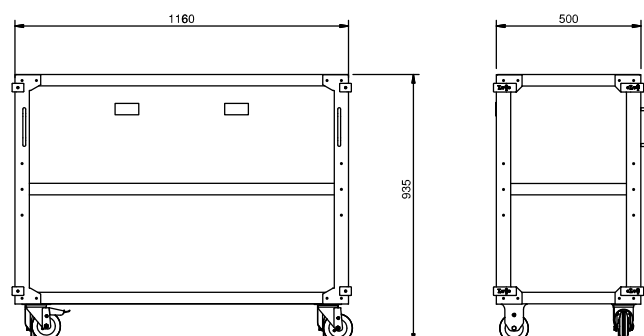

Struttura in lamiera elettrozincata e tubo di acciaio diam. 30 sp. 2 mm verniciati a polvere epossidica
Electro-galvanized steel structure and steel tube diam. 30, 2mm thick, painted with epoxy powder

Ripiani estraibili e regolabili di dimensioni 1224x640 mm e portata 40 kg cad.
1224x640mm extractable and adjustable shelves, with 40kg capacity each

2 Maniglie laterali ergonomiche resistenti a oli, grassi e carburanti
2 side ergonomic handles, resistant to oils, greases and fuels

Copertura ripiani in gomma antiscivolo e antiolio per evitare graffi e danneggiamenti alle carene
Shelves with skid proof and Anti-Oil rubber worktop cover to avoid scratches and damages to the fairings



SCEGLI IL COLORE
CHOOSE THE COLOR



Ruote industriali ad alta portata specifiche per carichi pesanti (di cui 2 fisse e 2 pivotanti)
Industrial wheels with high capacity, specific for heavy loads (two fixed and 2 pivoting)

EQC3R.PRC

Carrello porta carene a 3 ripiani
Fairing trolley with 3 shelves

Progettato e realizzato per riporre carene e parti ingombranti. Permette di ottimizzare lo spazio in officina ed efficientare il tuo lavoro.

Fornito smontato con istruzioni di montaggio .
Peso 65 kg.

Designed and created to put fairings and bulky parts. It allows you to optimize the space in your workshop and make your work more efficient.

Supplied disassembled with assembly instructions.
Weight 65 kg.

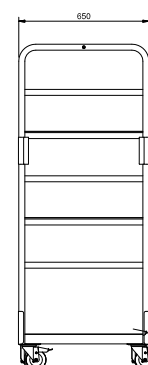
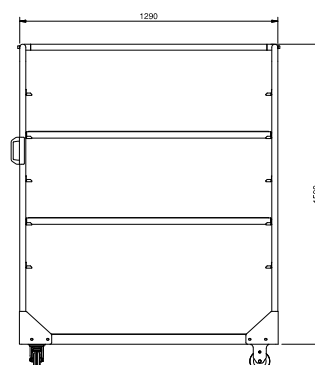

*Grazie al supporto a scomparsa il carrello può essere perfettamente integrato sotto i banchi di lavoro LV8
Thanks to the retractable support the trolley can be perfectly integrated under the LV8 workbenches



Supporto ergonomico a scomparsa per device diagnosi*
Retractable ergonomic support for diagnostic device*

Paracolpi laterali per evitare urti
Side bumpers to avoid damages



Arrotolatore di alimentazione
Power hose reel

Tasca in lamiera porta documenti.
Sheet-metal documents pocket

Copertura in ABS antiolio e antibenzina
Anti-oil and anti-petrol ABS cover

Cassetti per utensileria
Tools drawers



Organizer per cavi
Cables organizer

Prese elettriche
Electric Sockets

Ripiano scorrevole per mantentore di carica e manualistica
Charger and manuals sliding shelf

EQM3K1RD.7606

Carrello diagnosi
Diagnostic trolley

Progettato e realizzato per ospitare device per diagnosi, mantenitori di carica, arrotolatore di alimentazione, prese elettriche, utensileria e manualistica. Il supporto ergonomico per il device diagnosi è a scomparsa, il carrello pertanto può essere perfettamente integrato sotto i nostri banchi di lavoro.

Fornito montato
Peso 80 kg

Designed and created to storage diagnostic device, battery chargers, power hose reel, electric sockets, tools and manuals. The ergonomic support for the diagnostic device is retractable, so the trolley can be perfectly integrated under our workbenches.

Supplied Assembled
Weight 80 kgs

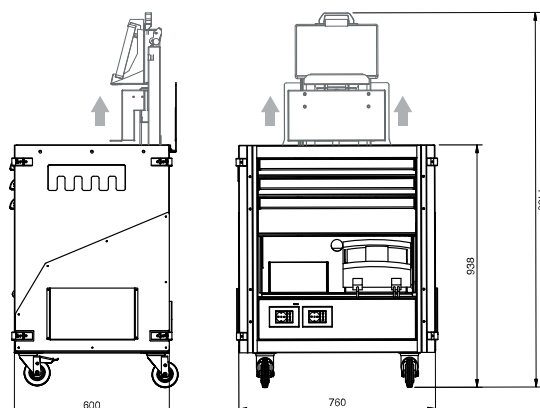
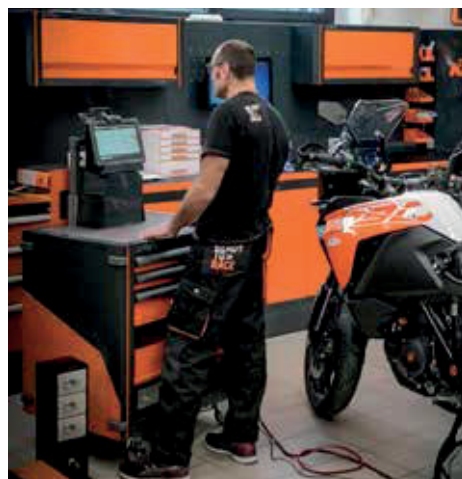

SUSPENSION BENCH

La prima workstation per lavorare su ogni tipo di sospensione motoclistica. Si tratta di una postazione di lavoro specifica progettata dai tecnici e designer LV8® in collaborazione con uno dei più importanti produttori di ammortizzatori mondiali, 100% made in LV8®.

The first workstation to operate on every kind of motorcycle suspension. It is been completely designed and created by the LV8® technicians in collaboration with one of the most important suspensions manufacturers, 100% made in LV8®.



Griglia in acciaio inox per fissare gli ammortizzatori
Stainless steel grid to fix the shock absorbers

Morsa da banco per fissare le forcelle
Bench vise to fix the forks

Piano di lavoro in acciaio inox con bordo di contenimento olio
Stainless steel Worktop with edge for the containment of the oil.

Vasca di raccolta in acciaio inox per l'olio usato
Stainless steel drain tank for used forks oil

Vaschetta estraibile per raccolta olio
Extractable oil collection tray

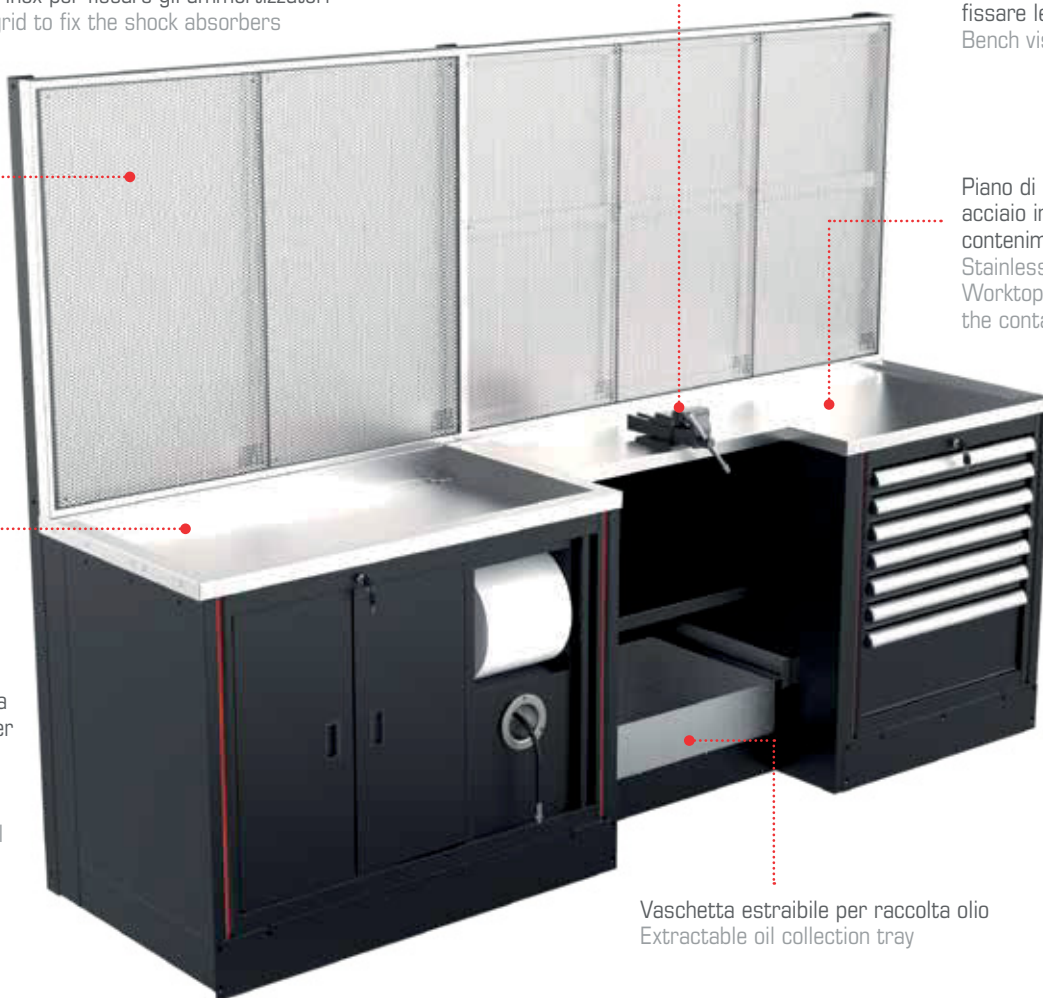

EQSB28-01

Configurazione L. 2800 con vasca, piano e doppia griglia in inox
L. 2800 mm configuration with stainless steel tank, worktop and double grid

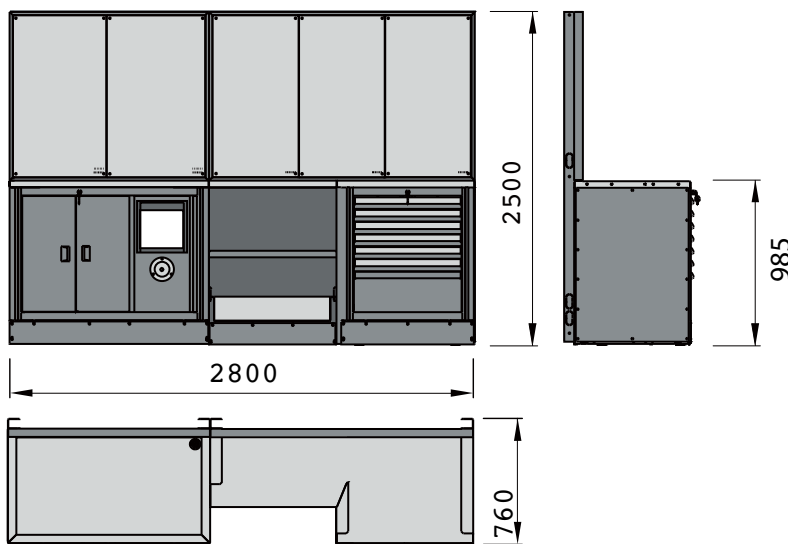

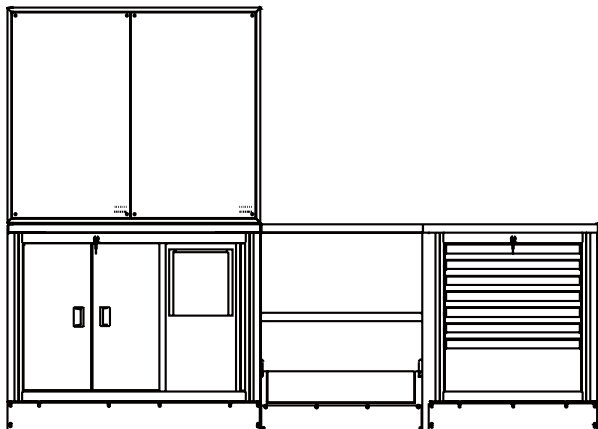

EQSB28-02

Configurazione L. 2800 mm con vasca, piano e
unica griglia in inox
L.2800 mm configuration with stainless steel
tank, worktop and single grid

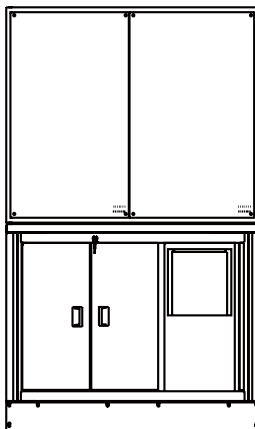

EQSB12-01

Configurazione L. 1200 mm con vasca e
unica griglia in inox
L.1200 mm configuration with stainless
steel tank and single grid

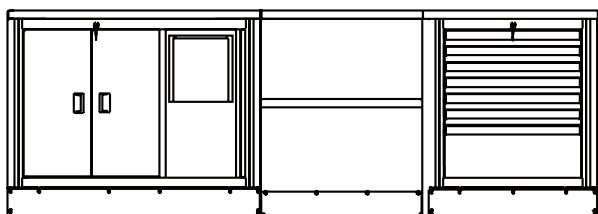

EQSB28-03

Configurazione L. 2800 mm
senza griglie
L.2800 mm configuration
without grids.



OPTION



E450SA

Smonta molle per mono ammortizzatore e per forcelle,
meccanico a vite
Shock-absorber disassembler, with mechanical screw
compression system



EQMM125

Morsa da banco Baum mm.125
Baum bench vice mm.125

GO TO PAGE ► 88

RACING BENCH

Il banco Racing, 100% made in LV8®, è dedicato alla preparazione dei veicoli racing e ideale per le manutenzioni all'interno di ambienti ristretti come i paddock. Il banco è composto da 2 moduli su ruote e una solida piana in legno multistrato. La facilità di movimentazione e lo smontaggio rapido agevolano gli operatori nelle frequenti operazioni di carico e scarico furgone-paddock.

The Racing bench, 100% Made in LV8®, is dedicated to the preparation of racing vehicles and perfect for the maintenance in small spaces such as paddocks. The bench is composed by 2 cabinets on wheels and a solid plywood worktop. The ease of handling and the rapid disassembly simplify the workers in the frequent operation of loading and unloading the paddock-truck.



SCEGLI IL COLORE CHOOSE THE COLOR

- R** RED RAL 3002
- B** BLUE RAL 5005
- O** ORANGE RAL 2009
- Y** YELLOW RAL 1021
- G** GREEN RAL 6018
- W** WHITE RAL 9016



Frontalino removibile di copertura ruote
Removable front panel to hide the wheels

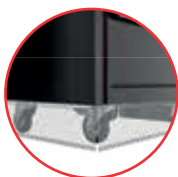

OPTION



EQAC-AR10

Arrotolatore aria con uscita M1/4"
Air hose reel with M1/4" exit



EQAC-ER10

Arrotolatore corrente 220V
1600W con 3 prese shuko
Electric cable reel 220V
1600W with 3 shuko sockets



EQR-01

Banco racing con cassettera a 6 cassetti e modulo servizio con cestino, portarotolo, presa e predisposizione arrotolatore.
Racing bench with 6 drawers cabinet and service module with rubbish bin, paper holder, socket and hose reel predisposition.



EQR-02

Banco racing con modulo a 2 ante e modulo servizio con cestino, portarotolo, presa e predisposizione arrotolatore.
Racing bench with 2 doors cabinet and service module with rubbish bin, paper holder, socket and hose reel predisposition.

RELATED PRODUCTS



E620RA



E600RA



E900T



E900P

GO TO PAGE ► 78-79

BATTERY MAINTENANCE STATION

Il pannello in acciaio inox con vaschette alloggiamento batterie è attrezzabile sino a un massimo di 10 caricabatterie ed è studiato per offrire una postazione ergonomica ed efficiente dedicata alla preparazione e manutenzione delle batterie al piombo e al litio. 100% made in LV8®.

The stainless steel wall panel with shelves for battery housing can be configured with up to 10 chargers. It is designed to offer an ergonomic and efficient location dedicated to the preparation and maintenance of lead and lithium batteries. 100% made in LV8®.

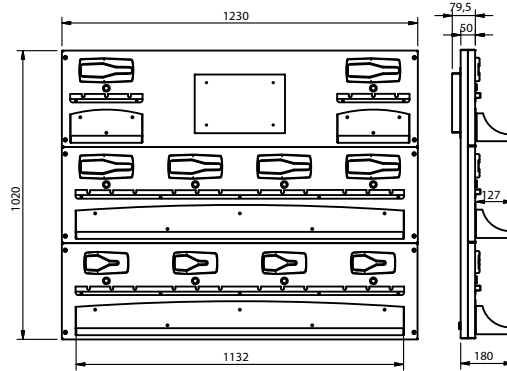

EQPCPO-01

Pannello in acciaio inox con predisposizione per alloggiamento 10 caricabatterie e quadro elettrico (optional)
Stainless steel wall panel with predisposition for housing 10 chargers and electric panel (options)

Su richiesta tagli laser specifici per alloggiare i caricabatterie del Cliente
On request specific laser cuts to house the Customer's chargers



Il pannello può essere integrato ai moduli di arredo LV8 con piano di lavoro a vasca in acciaio inox per consentire una facile pulizia e migliore conservazione nel tempo in caso di sversamento degli acidi utilizzati.

The panel can be integrated to the LV8 furniture modules with a stainless steel worktop with tank for a easy cleaning and better storage over time in case of spillage of the acids used.

OPTION



Quadro elettrico
Electric panel



ECBS0801

Shield 8 caricabatterie per batterie al piombo
SHIELD 8 charger for lead batteries



ECBSLT01

Shield LT caricabatterie per batterie al piombo e al litio
SHIELD LT charger for lead and lithium batteries



EIG-CBE600ADRCT

Contenitore con coperchio per la raccolta delle batterie esauste, impilabile e inattaccabile da acidi, grassi e solventi.
Dim. cm. 120x80x85h
Container for used batteries, stackable and resistant to acid, grease and oil.
Dim. cm. 120x80x85h



PADDOCK STANDS

MADE IN ITALY

Interamente progettati e costruiti all'interno della ns. Azienda i nostri cavalletti vengono prodotti e assemblati con componenti 100% Made In Italy per garantire massima affidabilità, qualità e sicurezza.

MATERIALI

La qualità dei materiali è imprescindibile nel settore del sollevamento, ecco perché utilizziamo materie prime sottoposte ad analisi chimiche, prove meccaniche e test di resistenza, munite di certificati di controllo specifico per garantire la completa rintracciabilità e qualità dei materiali.

MADE IN ITALY

Being entirely designed and manufactured within our firm, our paddock stands are produced and assembled with 100% Made In Italy components in order to ensure maximum reliability, quality and safety.

MATERIALS

The quality of the materials is essential in the lifting industry, that is why we use raw materials which underwent chemical analysis, mechanical and resistance tests, and which come with specific control certificates so as to guarantee the complete traceability and quality of the materials.

I cavalletti sono indispensabili per motociclisti e meccanici perché consentono lavori di manutenzione ordinaria e straordinaria, il lavaggio della moto e il rimessaggio invernale, evitando l'ovalizzazione delle gomme e le oscillazioni del cavalletto centrale che potrebbero far cadere la motocicletta.

I cavalletti così come gli scarichi, i coperchi serbatoio e i contrappesi sono un accessorio che concorre ad aumentare la Customer Experience, rafforzando il legame tra il motociclista e le Case Costruttrici.

LV8 ha lavorato negli anni per offrire soluzioni tecnicamente all'avanguardia ed esteticamente personalizzabili diventando marchio di riferimento sul mercato internazionale.

LV8 offre una gamma completa di cavalletti e accessori unici, adatti a qualsiasi moto, studiati nei minimi dettagli con accessori e packaging specifici per raggiungere i clienti di tutto il mondo in totale sicurezza.

Paddock stands are indispensable for bikers and mechanics because they allow ordinary and extraordinary maintenance work, the bike-washing and the winter storage, avoiding the ovalization of the tyres and the oscillations of the central stand that might drop the bike.

Paddock stands as well as the exhausts, tank covers and counterweights are an accessory that contributes to increase the Customer Experience, strengthening the link between the biker and the Motorcycle Manufacturers.

LV8 has worked over the years to offer customizable and technologically advanced solutions becoming a reference brand in the international market.

LV8 offers a complete range of unique paddock stands and accessories suitable for any motorcycle studied in the minutest of details with specific accessories and packaging, in order to reach clients all over the world in total safety.

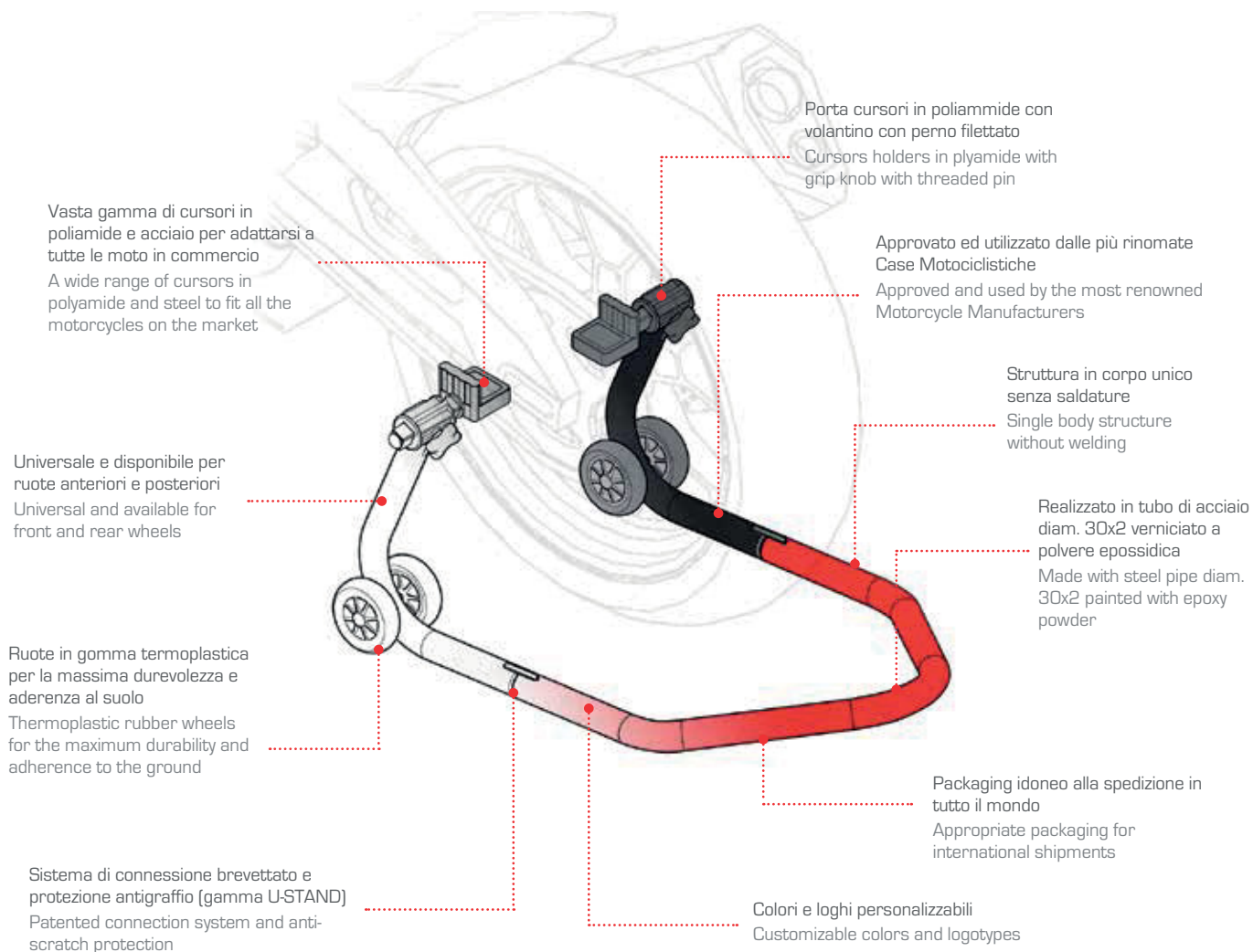

OEM

Grazie alla nostra divisione R&D siamo in grado di affiancare le più rinomate Case Motociclistiche e Marchi del settore nella realizzazione di cavalletti personalizzati, con l'obiettivo di esaltare le prestazioni delle moto e veicolare la propria brand identity.

BREVETTI

La continua innovazione che ci contraddistingue e l'utilizzo di componenti da noi brevettati ci permettono di offrire cavalletti e accessori unici. Ogni componente è sottoposto a periodiche analisi e stress test al fine di garantire prodotti affidabili e sicuri nel tempo.

OEM

Thanks to our R&D division we're able to support the renowned Motorcycle Manufacturers and Brands in the sector in the realization of customizable paddock stands, with the goal of enhancing the own brand identity.

PATENTS

The continuous innovation that distinguishes us and the use of patented components allow us to offer unique paddock stands and accessories. Every component is subjected to periodic analysis and stress test in order to ensure quality products guaranteed over time.

U | STAND

Caratteristiche tecniche:

- Cavalletto da assemblare, con sistema di connessione brevettato
- Inserimento manuale facile e veloce
- Nessun uso di viti e bulloni
- Verniciatura nera, rossa, blu, arancione, gialla, verde e bianca
- Senza saldature
- Porta cursore in poliammide
- 4 ruote colorate in gomma termoplastica

Technical features:

- Mountable stand with patented connection system
- Quick and easy manual connection
- No use of screws or bolts
- Black, red, blue, orange, yellow, green and white painting
- No welding
- Cursor-holder in polyamide
- 4 colored rubber covered wheels



U colorata a scelta:
Colored U at your choosing:



PATENTED



Sistema di connessione facile e brevettato
Patented and easy connection system.

Nessun uso di viti e bulloni
No use of screws or bolts

Diametro maggiorato che, a contatto col suolo, funge da protezione anti-graffio.
Increased diameter which offers an anti-scratch protection when in contact with the ground



Porta cursore in poliammide
Cursor-holder in polyamide

Gli U-STAND sono imballati singolarmente in una scatola di cartone robusta con interno fustellato al fine di proteggere il contenuto da tutte le possibili sollecitazioni durante i trasporti nazionali e internazionali.

Gli U-STAND, a differenza dei cavalletti tradizionali, permettono di ottimizzare i costi di trasporto e sono adatti per la distribuzione internazionale e la vendita online.

The U-Stands are packed singularly in a solid die-cut carton box, so as to protect the contents from any possible stress during national and international transportations.

The U-Stands, unlike traditional paddock stands, allow to optimize shipment costs and are suitable for international distribution and e-commerce.



cm. 59x30,5x44 kg 6,00

Scatola contenente un cavalletto U-Stand monobraccio sinistro (perno escluso)

Box containing one left-side single arm U-Stand (without pin)

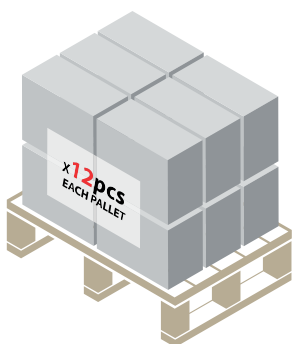

Le scatole U-STAND sono impilabili e adatte a tutte le tipologie di trasporto via camion e via mare.

Il singolo cavalletto, grazie alla scatola con interno fustellato, si presta inoltre alle spedizioni express e via aerea. Su un europallet cm. 120x80x145h è possibile impilare 12 cavalletti monobraccio oppure 42 cavalletti anteriori o posteriori. Grazie alla facile pallettizzazione delle scatole è possibile sfruttare al massimo la superficie dei magazzini e garantire movimentazioni più sicure.



cm. 51x45x11,5 kg 5

Scatola contenente un cavalletto U-Stand anteriore con coni oppure un cavalletto U-Stand posteriore con cursori a V o cursori in gomma.

Box containing one front U-Stand with cone cursors or one rear U-Stand with either V-fork or rubber cursors

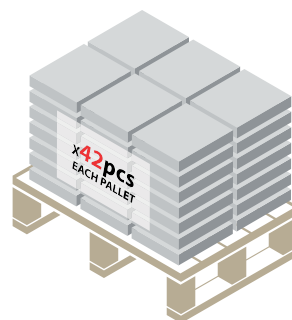

U-Stand boxes are stackable and are suitable for any sort of road or sea freight.

Thanks to the die-cut carton box, the single U-Stand can also be shipped by express delivery or by air. On one Euro pallet cm. 120x80x145h, we can stack 12 single arm U-Stand or 42 front or rear U-Stands. Thanks to the easy palletization of the boxes, it is possible to take full advantage of the warehouses surface area and therefore guarantee safer handlings.



COLORI DISPONIBILI

- R E600LC.KR
- G E600LC.KG
- B E600LC.KB
- W E600LC.KW
- O E600LC.KO
- B E600LC.BK
- Y E600LC.KY



E600LC

Cavalletto U-stand Anteriore Universale
con cursori a cono inclusi
Universal front U-stand with cone cursors
kit (included)

Cursori a cono (inclusi)
Cone cursors kit (included)

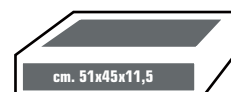

COLORI DISPONIBILI

- R E620LV.KR
- G E620LV.KG
- B E620LV.KB
- W E620LV.KW
- O E620LV.KO
- B E620LV.BK
- Y E620LV.KY



E620LV

Cavalletto U-stand Posteriore Universale con cursori a V
Universal rear U-stand with V fork cursors kit (included)

Cursori a V (inclusi)
V fork cursors kit (included)

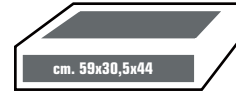

COLORI DISPONIBILI

- | | |
|-------------------|-------------------|
| R E630L.KR | G E630L.KG |
| B E630L.KB | W E630L.KW |
| O E630L.KO | B E630L.BK |
| Y E630L.KY | |

E630L

Cavalletto U-stand Posteriore Monobraccio (sinistro) senza perno
Single arm U-stand (left side) without pin



COLORI DISPONIBILI

- | | |
|--------------------|--------------------|
| R E620LG.KR | G E620LG.KG |
| B E620LG.KB | W E620LG.KW |
| O E620LG.KO | B E620LG.BK |
| Y E620LG.KY | |



E620LG

Cavalletto U-stand Posteriore Universale con cursori in gomma
Universal rear U-stand with rubber cursors kit (included)

Cursori in gomma (inclusi)
Rubber cursors kit (included)



R RED RAL 3000

B BLACK RAL 9005

Gli U-STAND permettono di abbinare il cavalletto ad ogni modello e brand di moto.

Le quattro ruote sono coordinate al colore del cavalletto verniciato in due finiture, una opaca (i bracci neri) e una lucida (la U colorata).

Le U verniciate sono perfettamente compatibili ai colori di tutte le livree ufficiali dei brand moto.

The U-Stands can be matched to every motorcycle brand and model.

The four wheels match the color of the U-Stand, which is painted in two finishes: one matte (the black arms) and one glossy (the colored U).

The painted Us are perfectly compatible with all the colors of every official livery of motorcycle brands.



O ORANGE RAL 2004

B BLACK RAL 9005



Y YELLOW RAL 1021

B BLACK RAL 9005



COLOR MATCHING WHEEL
Ruote con colore abbinato



MATTE FINISH
Finitura Opaca

GLOSSY FINISH
Finitura Lucida



B BLUE RAL 5002
B BLACK RAL 9005



G GREEN RAL 6018
B BLACK RAL 9005



W WHITE RAL 9016
B BLACK RAL 9005



B BLACK RAL 9005
matte black and gray wheels

DIAVOL

Caratteristiche tecniche

- Verniciatura nera opaca
- Senza saldature
- Porta cursore in poliammide
- 4 ruote in gomma termoplastica

Technical features

- Mat black painting
- No welding
- Cursor-holder in polyamide
- 4 rubber covered wheels



E620D

Cavalletto posteriore universale. **H: 36cm**
Universal rear stand. **H: 36cm**



E620/09

Cursori in gomma
Rubber cursors kit



E620/08C

Cursori a V
V fork cursors kit



E620DL

Cavalletto posteriore LOW per Suzuki. **H: 30cm**
Rear low stand for Suzuki. **H: 30cm**



E620/08C

Cursori a V
V fork cursors kit



E620DL+

Cavalletto posteriore LOW+ per Suzuki B-King e Hayabusa. **H: 27cm**
Ideale per moto con nottolini in posizione ribassata e di peso elevato

Rear LOW+ stand for Suzuki B-King and Hayabusa. **H: 27cm**
Suitable for heavy motorcycles with low-set bobbins



Imballo dei cursori
Cursors kit packaging



E620/08C

Cursori a V
V fork cursors kit



Imballo dei nottolini
Bobbins kit packaging

Colori disponibili

A = argento
N = nero
T = titanio

Available colours

A = silver
N = black
T = titanium



E201/08125 A E201/08125 N E201/08125 T

Nottolini in alluminio
M8x1,25 (Suzuki, Honda, Ducati,
Triumph*)
Aluminium bobbins
M8x1,25 (Suzuki, Honda, Ducati,
Triumph*)

*per Triumph Speed Triple e Tiger 800 è necessario il kit E201/08K
E201/08K is necessary for Triumph Speed Triple and Tiger 800



E201/08K

Kit adattatori Triumph Street
Triple e Tiger 800
Triumph Street Triple and Tiger
800 adapters kit



E201/06100 A E201/06100 N E201/06100 T

Nottolini in alluminio
M6x1 (Aprilia, Yamaha)
Aluminium bobbins
M6x1 (Aprilia, Yamaha)



E201/10100 A E201/10100 N E201/10100 T

Nottolini in alluminio
M10x1,50 (Ktm)
Aluminium bobbins
M10x1,50 (Ktm)



E201/10125 A E201/10125 N E201/10125 T

Nottolini in alluminio
M10x1,25 (Kawasaki)
Aluminium bobbins
M10x1,25 (Kawasaki)



E630DR

Cavalletto monobraccio destro, senza perno
Right side single arm stand, without pin



E630D

Cavalletto monobraccio sinistro, senza perno
Left side single arm stand, without pin



E630DS

Cavalletto monobraccio per scooter BMW, senza perno
Single arm stand for BMW scooter, without pin



E630/03B28

Perno per scooter BMW escluso
BMW scooter pin not included

DUCATI



E630/03DX

Ducati DX/Right
848 08-10, 848 EVO

BMW



E630/03B30

BMW F 650 CS, F800
S/ST



E630/03B50.5

BMW R 1200 GS/R/RT

HONDA



E630/03HC18D

Honda CB1000R 18 ≥
2018 – dx



ADD THE PIN

KTM



E630/03K

KTM 1290 Super Duke R

BMW



E630/03B52.9

BMW K 1200, K 1300 R/S/
RS/RT/GT, R 1200 S/ST, HP2

TRIUMPH



E630/03T

Triumph Daytona, Speed
Triple



E630/03D40

Triumph Speed Triple
RS 2021

DUCATI



E630/03D

Ducati 748, 848, 916, 996,
998, Monster, Multistrada
1000/1100, Hypermotard



E630/03D40

Ducati 1098/1198, Diavel,
Multistrada 1200,
Streetfighter, Panigale



E630/03D42

MV-Agusta e Ducati Ø 42
(1098/1198)

HONDA



E630/03H

Honda Crossrunner, VFR



E630/03HC

Honda CB1000R ≤ 2017



E630/03HC18S

Honda CB1000R 18 ≥ 2018 – sx



E6200B

Cavalletto posteriore per Triumph Bonneville - Truxton - Scrambler
 Rear stand for Triumph Bonneville - Truxton - Scrambler



E600D

Cavalletto anteriore universale
 Universal front stand



E600/03

Cursori a rulli
 Roller cursors kit



E600/07

Cursori a cono
 Cone cursors kit



E600/08

Cursori a cono
 asimmetrici
 Asymmetric cone
 cursors kit



E601D

Cavalletto anteriore fisso
 Front fixed stand





E600DH

Cavalletto anteriore alto per moto con pinza radiale
Front high stand for motorbikes with radial brakes



E620/07

Supporti in gomma per pinza radiale
Rubber cursors kit for radial brakes



E611S

Cavalletto anteriore a leva per canotto sterzo con perno universale
e piastra per MV-Agusta e Ducati
Front under-yoke stand with lever with universal pin and plate for
Mv-Agusta and Ducati



Perno conico in acciaio
Steel conic pin



Piastra per MV-Agusta
e Ducati
Plate for MV-Agusta
and Ducati



E610DP

Cavalletto anteriore per canotto sterzo
Front under-yoke stand



Kit 7 perni
7 pin kit



E640H

Cavalletto centrale per Honda VFR 1200 F e Crosstourer
Honda VFR 1200 F and Crosstourer central stand



E640H-PIN

Kit perni
Pin kit



E640

Cavalletto centrale universale a perno passante
Universal central stand with through axle



E640-PIN10

Perno Ø 10
Ø 10 pin



E640-PIN12

Perno Ø 12
Ø 12 pin



E640-PIN158

Perno Ø 15/8
Ø 15/8 pin



E601DT

Cavalletto anteriore fisso per T-MAX 2012 e successivi
Front fixed stand for T-MAX 2012 and later



E620DT

Cavalletto posteriore per T-MAX 2012 e successivi. Includi cursori in gomma
Rear stand for T-MAX 2012 and later. Rubber cursors kit included



Supporti in gomma inclusi
Rubber cursors kit included

EXPRESS YOUR BRAND

Su richiesta e quantità, tutti i cavalletti Diavol possono essere personalizzati con colori e loghi in linea con la tua brand identity.

On request and quantity, all the Diavol paddock stands can be customized with colors and logotypes in accordance with your brand identity.



STEP 1

Scegli il colore del cavalletto
Choose the color of
the paddock stand



STEP 2

Scegli il colore della ruota
Choose the color of
the wheel



STEP 3

Inviaci il tuo logo per creare l'adesivo
Send us your logotype to create
the sticker

RACING

Caratteristiche tecniche

- Tubo in alluminio verniciato nero opaco
- Forchette in alluminio ricavate dal pieno, fissate al tubo mediante boccola ad espansione
- Supporti in alluminio ricavati dal pieno con rulli in nylon per pinze radiali, fissati al tubo mediante boccole ad espansione
- Ruote in nylon con cuscinetti a sfera

Technical features

- Aluminium pipe, mat black painted.
- Milled aluminium fork adaptors fixed through expansion bushes
- Milled aluminium adaptors with nylon rollers for radial brakes fixed through expansion bushes
- Nylon wheels with ball bearings



E620RA

Cavalletto posteriore in alluminio
Aluminium rear stand



Cursori a forchetta
in alluminio
Aluminium fork cursors



E600RA

Cavalletto anteriore in alluminio
Aluminium front stand



Cursori a rullo in alluminio
Aluminium rollers cursors

Dimensioni

- Altezza: 570mm
- Larghezza: 660mm
- Lunghezza: 2000mm
- Lunghezza rampa: 1950mm
- Peso: 29Kg
- Portata: 250Kg

Dimensions

- Height: 570mm
- Width: 660mm
- Length: 2000mm
- Ramp length: 1950mm
- Weight: 29Kg
- Capacity: 250Kg



LEGGERO E PIEGHEVOLE.
LIGHT AND FOLDABLE.

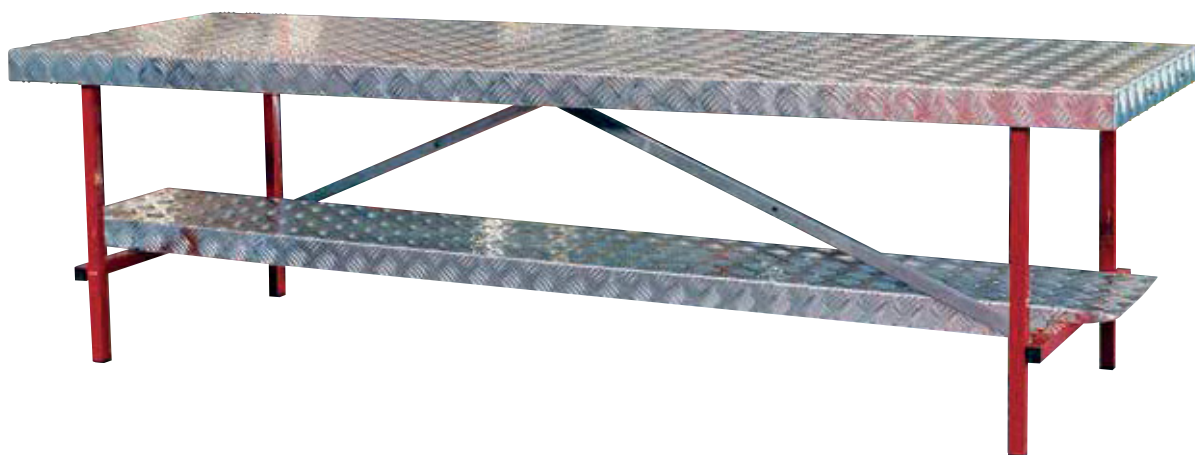

E400R

Banco di lavoro in alluminio antiscivolo con piedi richiudibili e rampa di salita removibile
Anti-skid aluminium workbench with foldable tubular legs and removable ramp



E900T

Coppia cavalletti centrali per telaio con asta inclusa (H: 67-102cm)
Central stands for frame with steel tube rod (H: 67-102cm)



E900P

Coppia cavalletti centrali per pedana poggiapiedi (H: 38-56cm)
Central stands for footpeg rests (H: 38-56cm)

OFF ROAD



Dimensioni

- Altezza minima: 290mm
- Altezza massima: 400mm.
- Appoggio: 300x150mm.
- Peso: 7,5Kg

Dimensions

- Minimum height: 290mm
- Maximum height: 400mm.
- Support: 300x150mm.
- Weight: 7,5Kg



Dimensioni

- Altezza minima: 250mm
- Altezza massima: 350mm.
- Appoggio: 300x230mm.
- Peso: 7,5Kg

Dimensions

- Minimum height: 250mm
- Maximum height: 350mm.
- Support: 300x230mm.
- Weight: 7,5Kg

E800L

Cavalletto Cross
Cross stand

E800M

Cavalletto Motard
Motard stand



Dimensioni

- Altezza: 410mm
- Appoggio: 300x220mm.
- Peso: 2,5Kg

Dimensions

- Height: 410mm
- Support: 300x220mm.
- Weight: 2,5Kg



E800CF

Cavalletto cross racing in alluminio
Aluminium racing cross stand

GARAGE

"Sotto cavalletti" utilizzabili con tutte le moto e scooter provviste di cavalletto centrale e Scooter Honda SH. Equipaggiati con 4 ruote girevoli in poliuretano, due delle quali con freno, consentono di spostare il veicolo in tutte le direzioni agevolandone il parcheggio in garage e in spazi ristretti.

"Under stands" for any kind of motorcycle or scooter with central stand and Honda SH Scooter. Equipped with 4 polyurethane caster wheels, 2 with brakes, they are used to move the vehicle in all directions making parking operations in the garage and in tight spaces easier.



E300MM+

Motomoving con copertura in gomma antiscivolo
Motomoving with anti-skid rubber covering

E300MM-EXT

Estensione per cavalletto laterale
Extension for side stand



E300SC

Motomoving per Scooter Honda SH
Scooter Honda SH Motomoving

VAN EQUIPMENT

Grazie ad un'ampia gamma di piani, scaffali, cassettiere, attrezzature ed accessori made in Italy siamo in grado di allestire furgoni e veicoli commerciali da adibire a trasporto/recupero mezzi, officina mobile, racing team e assistenza in pista. Leggerezza e flessibilità, per una maggiore capacità di carico e riduzione del peso, sono garantiti dall'utilizzo di materiali leggeri come l'alluminio.

Thanks to a wide range of Made in Italy worktops, shelves, cabinets, equipment and accessories, we are capable of setting up vans and commercial vehicles to be used for vehicle transportation/recovery, as movable workshop, racing team and assistance on the racetrack. Lightness and flexibility, which allow a higher load capacity and a weight reduction, are ensured thanks to the use of light materials such as aluminum.





ANALISI DEL MEZZO

Modello, versione del mezzo e campo di utilizzo sono le informazioni preliminari necessarie per iniziare il nostro studio di progettazione.

ANALYSIS OF THE VEHICLE

Model, vehicle version and field of use are the preliminary information we need to begin with our design study.



PROGETTAZIONE

In base alle esigenze del cliente vengono sviluppati rendering per una simulazione realistica e ad alta definizione del progetto di allestimento.

DESIGN

On the basis of the client's needs, we develop 3D renderings for a realistic high resolution simulation of the project.



MONTAGGIO

Attraverso una rete di installatori specializzati in Italia e all'estero garantiamo montaggi professionali e la riconsegna del mezzo "chiavi in mano".

ASSEMBLY

By means of our qualified technicians' network in Italy and Europe, we guarantee professional installations and a turnkey vehicle restitution.



I nostri allestimenti in alluminio sono pensati per aumentare l'efficienza, ridurre i consumi di carburante e aumentare la portata del tuo furgone. Ogni allestimento è progettato su misura per soddisfare le esigenze di ogni cliente.

Our aluminum equipment is intended to increase the efficiency, reduce the fuel consumption and enlarge the capacity of your van. Every fitting is designed custom-made to satisfy any client's needs.

OPTION



PIANO DI LAVORO CON RIVESTIMENTO IN INOX
WORKTOP WITH STAINLESS STEEL COATING

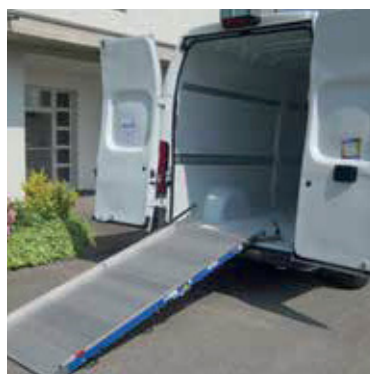

RAMPA DI CARICO
LOADING RAMP



COMPRESSORE
COMPRESSOR



GENERATORE
POWER UNIT



INVERTER E BATTERIA AUSILIARIA
INVERTER AND AUXILIARY BATTERY



VALIGIE E BOX
SUITCASES AND BOXES



EWCAF

Morsa automatica per furgone
Automatic wheel vise for trucks and vans

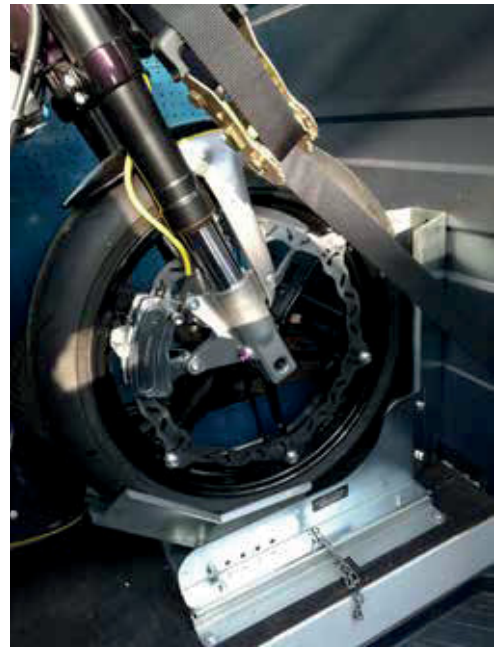

EWCAF.KC

Set due flange per fissare la morsa
automatica ai carrelli a binario
Two flange set to fix automatic wheel
vise on trailer with lanes.



EWCAF.KP

Set piedi di allargamento per morsa
per furgoni con appoggi in plastica
Enlargement foot set with plastic feet
for automatic wheel vise.

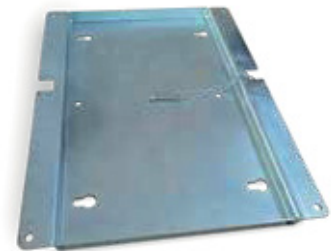

EWCAF.KS

Piastra versione sgancio rapido
Quick release version plate



ERAMP

Rampa in alluminio 230x2200
Aluminium ramp 230x2200



E450SA

Smonta molle per mono ammortizzato-
re e per forcelle, meccanico a vite
Shock-absorber disassembler, with
mechanical screw compression
system



EQMM125

Morsa da banco Baum mm.125
Baum bench vice mm.125



Lv8

Moto Guzzi

Lv8 L860

www.lv8.it
100% MADE IN ITALY

FRONT CONE CURSORS
REAR V FORK CURSORS
REAR RUBBER CURSORS

Lv8



**ATTREZZATURE E UTENSILERIA
GARAGE EQUIPMENT AND TOOLS**



SHOCK-ABSORBER DISASSEMBLER

Lo smonta molle universale, progettato e costruito interamente in LV8, è perfetto per ogni moto: motocross, enduro, trial, supermotard, supersportive, naked e scooter. Ideato per comprimere le molle di forcelle e monoammortizzatori in totale sicurezza facilitando la rimozione della ghiera di tensione.

The shock-absorber disassembler, entirely designed and made in LV8, is perfect for every motorcycle: motocross, enduro, trial, supermotard, supersport, naked e scooter. Conceived to compress the springs of forks and shock absorbers in total safety, facilitating the removal of the tension ring.



E450SA.F74
Adattatore incluso 74 mm
Included adapter 74 mm

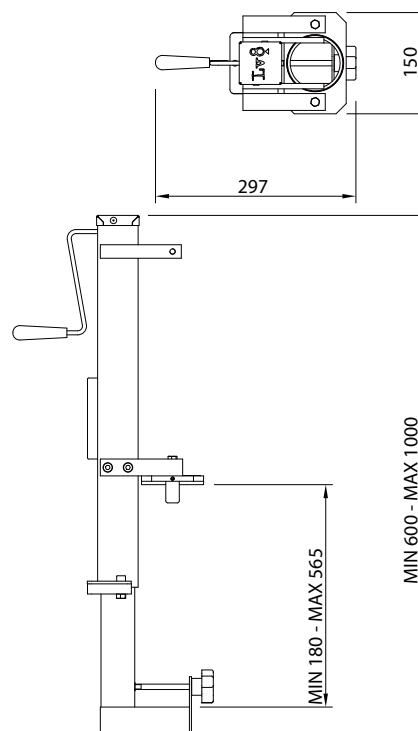

E450SA

Smonta molle per mono ammortizzatore e per forcelle, meccanico a vite
Shock-absorber disassembler, with mechanical screw compression system

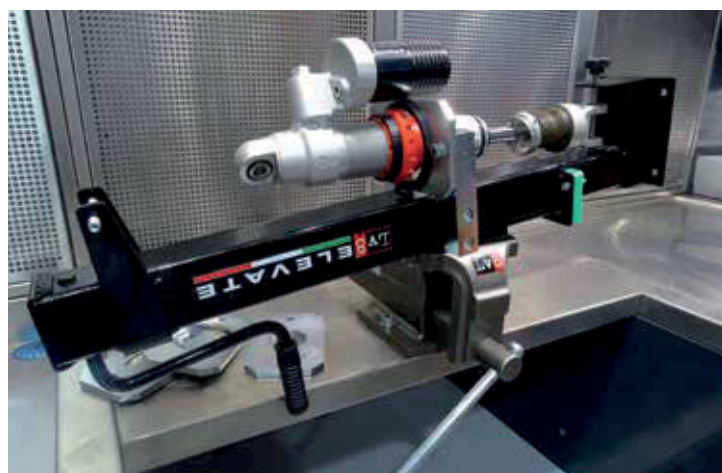

OPTION



E450SA-FK OPTIONAL ADAPTER KIT

45mm	E450SA.F45
47mm	E450SA.F47
50mm	E450SA.F50
53mm	E450SA.F53
56mm	E450SA.F56
59mm	E450SA.F59
62mm	E450SA.F62
68mm	E450SA.F68
71mm	E450SA.F71
75mm	E450SA.F75
77mm	E450SA.F77
80mm	E450SA.F80
84mm	E450SA.F84
87mm	E450SA.F87

TYRE CHANGERS



E0250

"Obelix" - smontagomme automatico - rosso std
 "Obelix" - automatic tyre changer - red std.

Caratteristiche tecniche

Smontagomme automatico con palo ribaltabile automatico e doppia velocità di rotazione dell'autocentrante.
 Disponibile nelle versioni 230V o 380V.

Technical Features

Automatic tyre changer with automatic tilting column and two speed chuck rotation. Available versions 230V or 380 V.



E0212

"Asterix" - smontagomme semi-automatico - nero opaco std.
 "Asterix" - semi-automatic tyre changer - mat black std.

Caratteristiche tecniche

Smontagomme semi-automatico con palo fisso e braccio a bandiera.
 Disponibile nelle versioni 230V o 380V.

Technical Features

Semi-automatic tyre changer with fixed column and swing arm.
 Available versions 230V or 380 V.

	E0250 Obelix	E0212 Asterix
Dimensioni Dimensions	mm 1590x1150x1770h	mm 940x1025x1825h
Peso netto Net weight	205 kg	150 kg
Diametro max ruota Max wheel diameter	1000 mm	1000 mm
Capacità di serraggio Clamping capacity	10" – 23"	5" – 23"
Largezza max ruota Max wheel width	320 mm (12,5")	320 mm (12,5")
Motore elettrico trifase 3-phase Electric motor	0,55KW (0,75HP)	0,55KW (0,75HP)
Motore elettrico monofase 1-phase Electric motor	0,75KW (1,0HP)	0,75KW (1,0HP)
Pressione esercizio circuito pneumatico Pression of pneumatic circuit	8-10 BAR (116-145 PSI)	8-10 BAR (116-145 PSI)

STATIC WHEEL BALANCER



E9152KC

Kit asta centraggio cerchi
Rim centering kit



E9152A

Equilibratrice manuale
Static wheel balancer

Caratteristiche tecniche

Indispensabile per l'equilibratura delle ruote in officina o sui campi di gara. È equipaggiata con cuscinetti volventi, livella di posizionamento e quattro piedini regolabili per ottenere la massima precisione. È dotata di una coppia di coni che si adattano a qualsiasi tipo di mozzo.

Technical Features

Suitable for wheel balancing in the workshop or on racing tracks. This static wheels balancer is supplied with a rod and two locking cones that fit any kind of hub. The rod works on special bearings that allow the wheel to rotate smoothly for precise adjustment. It is equipped with a rebbet level and four adjustable feet to get the proper perpendicular and the most precise parallelism to the base.



E9152K-K1290

Kit adattatori per KTM
1290 Super Duke R
Adapters kit for KTM
1290 Super Duke R



E9152KB

Kit adattatori per BMW
Adapters kit for BMW



E9152KM

Kit adattatori per ruote
monobraccio
Adapters kit for single-arm
wheels



E9152KS

Kit adattatori per scooters e
maxi scooters
Adapters kit for scooters and
maxi scooters



E9152KS2

Kit adattatori per scooter
PIAGGIO MP3
Adapters kit for scooter
PIAGGIO MP3

ELECTRONIC WHEEL BALANCERS



Pannello di controllo 3D per accedere a tutte le funzioni
3D Console to access all functions.

Vani portapesi, portautensili e portaconi.
Compartments for weights, tools and cones

OPTION

Adattatori Ducati, Triumph, BMW, MV Agusta, Honda, Aprilia, quad e scooter a richiesta

Adapter for Ducati, Triumph, BMW, MV Agusta, Honda, Aprilia, quad and scooter on request

DISPONIBILE ANCHE IN NERO
ALSO AVAILABLE IN BLACK



E102B

La versione compatta utilizzabile ovunque: su un banco di lavoro o in un furgone, dove lo spazio è ristretto ma sono richieste alte prestazioni.

The compact version usable everywhere: on a workbench or in a van, where space is restricted and top performance are still needed.

Albero fisso di 14 mm con bussole e coni di bloccaggio per bloccare agevolmente la maggior parte delle ruote da moto.

14 mm motorcycle shaft with several adapters to lock properly most motorcycle wheels.

Sistema a 3 sensori.
3 sensors system.

Misura esatta dello Squilibrio Dinamico.
Measurement of the Dynamic Unbalance.

E202B

E202B permette di effettuare l'equilibratura statica e dinamica di ogni tipo di ruota da moto. È dotata di un modernissimo microprocessore a 16 bit e di un nuovo programma di equilibratura con molte funzioni di serie. E202B è equipaggiata con il sistema meccanico di rilevamento degli squilibri TriSensor e con un sistema ad albero fisso che consente di simulare le esatte condizioni di rotolamento della ruota sulla strada.

E202B allows static and dynamic balancing of all types of motorcycle wheel. E202B incorporates the latest low-speed technology with 16-bit electronics and new balancing program with many features standard. The heart of the balancer is built around the TriSensor System and system on fixed shaft that allows to simulate the exact conditions of rolling on the road.

Caratteristiche tecniche (di entrambe E102B e E202B) / Technical features (of both E102B and E202B)

Alimentazione elettrica / Power supply	12V (220V di serie)
Potenza assorbita / Power Source	5 Watt
Velocità di rotazione / Balancing speed	75-125 RPM
Diametro cerchio / Rim diameter	8 - 26" (200 - 650 mm)
Diametro ruota / Wheel diameter	max 34" (850 mm)
Larghezza ruota / Wheel Width	max 16" (415 mm)
Larghezza minima per dinamica / Minimum rim width (dynamic mode)	2" (50 mm)
Peso ruota / Wheel Weight	max 30Kg (66 Lbs)
Tempo di equilibratura / Working time	8 - 15 s.
Precisione / Accuracy	1 gr.
Livello rumore / Noise	< 70 dB

WASHING TRAY

La soluzione ottimale per il lavaggio dei pezzi, compatibile con tutti i materiali: metalli, gomme, pvc, parti elettriche e parti verniciate. Compact è la lavapezzi dal design compatto. Offre un sistema di pulizia manuale comodo e veloce, sicuro ed eco-compatibile. La resistente struttura di plastica ad alta densità (PE) è riciclabile, i liquidi privi di VOC hanno una lunga durata di vita utile.

The optimal solution for your parts washing, compatible with all materials: metals, rubbers, pvc, electrical parts, painted parts. Compact is a parts washer system with a compact design. Easy handling, fast, safe and eco-friendly cleaning system. The sturdy plastic (PE) device is recyclable, the VOC-free Liquids have long service lives.



EG50026

Vasca di lavaggio Compact
Compact washing tray

Dimensioni/Dimensions	74 x 54 x 104 h
Temperatura di esercizio/Operating temperature	41°
Capacità max/Max capacity	90 kg
Capacità di carico/Load capacity	100 lt
Configurazione elettrica/Electrical configuration	230 V



La vasca di lavaggio Compact può essere perfettamente integrata all'interno degli arredi LV8.
The Compact washing tray can be perfectly integrated inside the LV8 furnishings.

OPTION



EG50327

Coperchio per proteggere dallo sporco e ridurre l'evaporazione del liquido
Lid to protect from contamination and reduce cleaning liquid evaporation



EG50427

Kit ruote per facilitare il trasporto
Wheel kit for easy transport



A02026

Detergente, tanica da 20 lt
Cleaner, tank of 20 lt
Non contiene solventi e composti organici volatili (COV).
It is free from solvents and volatile organic compounds (VOC)

PRESSES



EPR10BPM
(10 ton)

EPR15BPM
(15 ton)

Pressa idraulica da banco con pistone mobile
Hydraulic workbench press with movable piston

DISPONIBILE ANCHE IN NERO
ALSO AVAILABLE IN BLACK

Caratteristiche tecniche Technical Features

- Pompa a mano a due velocità Double-speed hand pump
- Sicurezza idraulica in caso di sovraccarico Overload safety-valve
- Ritorno automatico del pistone Automatic return of the ram
- Stelo cromato Chromium plated rod
- Manometro Pressure gauge
- Serie di prismi a V V-blocks



EPR10PM
(10 ton)

EPR20PM
(20 ton)

Pressa idraulica a colonna con pistone mobile
Hydraulic press with movable piston

DISPONIBILE ANCHE IN NERO
ALSO AVAILABLE IN BLACK

Caratteristiche tecniche Technical Features

- Pompa a mano a due velocità Double-speed hand pump
- Sicurezza idraulica in caso di sovraccarico Overload safety-valve
- Ritorno automatico del pistone Automatic return of the ram
- Stelo cromato Chromium plated rod
- Manometro Pressure gauge
- Serie di prismi a V V-blocks

OPTION



EPR-OPTION2

Kit piastra cacciaspina e punzoni
Per pressa 10 ton
Press plate + punch set
For press 10 ton



EPR-OPTION3

Kit piastra cacciaspina e punzoni
Per pressa 15 ton
Press plate + punch set
For press 15 ton

EPR-OPTION4

Kit piastra cacciaspina e punzoni
Per pressa 20 ton
Press plate + punch set
For press 20 ton



EPR-OPTION1

Comando a pedale (optional)
Pedal drive (optional)

TOOLS

GLI ASSORTIMENTI SI ADATTANO AL CASSETTO DEI NOSTRI CARRELLI E CASSETTIERE L. 800 MM
THE ASSORTMENTS ARE SUITABLE TO THE DRAWERS OF OUR CABINETS AND TROLLEYS L. 800 MM

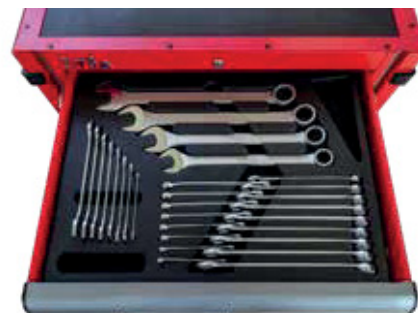

EUT-FK-C1

Assortimento chiavi combinate e a forchetta
 Combination and open end wrenches set

CHIAVE COMB., TIPO LUNGO - DA 6 mm A 22 mm	COMB. WRENCHES, LONG TYPE - FROM 6 mm TO 22 mm	Pz. 17
CHIAVE COMB., TIPO LUNGO - 24 mm	COMB. WRENCHES, LONG TYPE - 24 mm	Pz. 1
CHIAVE COMB., TIPO LUNGO - 27 mm	COMB. WRENCHES, LONG TYPE - 27 mm	Pz. 1
CHIAVE COMB., TIPO LUNGO - 30 mm	COMB. WRENCHES, LONG TYPE - 30 mm	Pz. 1
CHIAVE COMB., TIPO LUNGO - 32 mm	COMB. WRENCHES, LONG TYPE - 32 mm	Pz. 1
CHIAVE A FORCH. - 6x7 mm	OPEN END WRENCHES - 6x7 mm	Pz. 1
CHIAVE A FORCH. - 8x9 mm	OPEN END WRENCHES - 8x9 mm	Pz. 1
CHIAVE A FORCH. - 10x11 mm	OPEN END WRENCHES - 10x11 mm	Pz. 1
CHIAVE A FORCH. - 12x13 mm	OPEN END WRENCHES - 12x13 mm	Pz. 1
CHIAVE A FORCH. - 14x15 mm	OPEN END WRENCHES - 14x15 mm	Pz. 1
CHIAVE A FORCH. - 16x17 mm	OPEN END WRENCHES - 16x17 mm	Pz. 1
CHIAVE A FORCH. - 18x19 mm	OPEN END WRENCHES - 18x19 mm	Pz. 1
CHIAVE A FORCH. - 20x22 mm	OPEN END WRENCHES - 20x22 mm	Pz. 1
TOTALE	TOTAL	Pz. 29



EUT-FK-C2

Assortimento giraviti piatti e a croce
 Flat and crosstip screwdrivers set

GIRAV. PER VITI CON INL TBI - 0,4x2,5 mm	SCREWDR. FOR SCREWS WITH TBI CUT - 0,4x2,5 mm	Pz. 1
GIRAV. PER VITI CON INL TBI - 0,5x3 mm	SCREWDR. FOR SCREWS WITH TBI CUT - 0,5x3 mm	Pz. 1
GIRAV. PER VITI CON INL TBI - 0,8x4 mm	SCREWDR. FOR SCREWS WITH TBI CUT - 0,8x4 mm	Pz. 1
GIRAV. PER VITI CON INL TBI - 1x5,5 mm	SCREWDR. FOR SCREWS WITH TBI CUT - 1x5,5 mm	Pz. 1
GIRAV. PER VITI CON INL TBI - 1,2x6,5 mm	SCREWDR. FOR SCREWS WITH TBI CUT - 1,2x6,5 mm	Pz. 1
GIRAV. PER VITI CON INL TBI - 1,2x8 mm	SCREWDR. FOR SCREWS WITH TBI CUT - 1,2x8 mm	Pz. 1
GIRAV. CORTO PER VITI CON INTBI - 0,8x4 mm	SHORT SCREWDR. FOR SCREWS WITH TBI CUT - 0,8x4 mm	Pz. 1
GIRAV. CORTO PER VITI CON INTBI - 1,2x6,5 mm	SHORT SCREWDR. FOR SCREWS WITH TBI CUT - 1,2x6,5 mm	Pz. 1
GIRAV. A CROCE (PH) TBI - PH0	TBI CROSSTIP (PH) SCREWDR. - PH0	Pz. 1
GIRAV. A CROCE (PH) TBI - PH1	TBI CROSSTIP (PH) SCREWDR. - PH1	Pz. 1
GIRAV. A CROCE (PH) TBI - PH2	TBI CROSSTIP (PH) SCREWDR. - PH2	Pz. 1
GIRAV. A CROCE (PH) TBI - PH3	TBI CROSSTIP (PH) SCREWDR. - PH3	Pz. 1
GIRAV. CORTO A CROCE (PH) TBI - PH2	SHORT TBI CROSSTIP (PH) SCREWDR. - PH2	Pz. 1
SERIE GIRAV. EXTRA LUNGHI INTERCAMBIABILI: T10 - T15 - T20 - T25 - T27 - T30 - T40 TS10 - TS15 - TS20 - TS25 - TS27 - TS30 - TS40	EXTRA LONG INTERCHANGEABLE SCREWDR. TSE T10 - T15 - T20 - T25 - T27 - T30 - T40 TS10 - TS15 - TS20 - TS25 - TS27 - TS30 - TS40	Pz. 9
TOTALE	TOTAL	Pz. 22



EUT-FK-C3

Assortimento pinze, tenaglia e tronchese
 Pliers, tower pincers and cutting nippers set

PINZA IDRAULICO - Lu: 250 mm	WATER PUMP PLIERS - Le: 250 mm	Pz. 1
TENAGLIA CEMENTISTA - Lu: 220 mm	TOWER PINCERS - Le: 220 mm	Pz. 1
PINZA PER AN EL. INT. DRI. - AN: Ø 8 ÷ 13 mm - BECCO: 40 mm	INT. LOCK RINGS PLIERS, STRA. - CIRC Ø8 ÷ 13 mm - BEAK: 40 mm	Pz. 1
PINZA PER AN EL. INT. DRI. - AN: Ø 12 ÷ 25 mm - BECCO: 40 mm	INT. LOCK RINGS PLIERS, STRA. - CIRC Ø12 ÷ 25 mm - BEAK: 40 mm	Pz. 1
PINZA PER AN EL. INT. DRI. - AN: Ø 19 ÷ 60 mm - BECCO: 52 mm	INT. LOCK RINGS PLIERS, STRA. - CIRC Ø19 ÷ 60 mm - BEAK: 52 mm	Pz. 1
PINZA PER AN EL. INT. PIEG. - AN: Ø 8 ÷ 13 mm - BECCO: 285 mm - H: 125 mm	INT. LOCK RINGS PLIERS, BENT - CIRC: Ø 8 ÷ 13 mm - BEAK: 28,5 mm - H: 12,5 mm	Pz. 1
PINZA PER AN EL. INT. PIEG. - AN: Ø 12 ÷ 25 mm - BECCO: 285 mm - H: 125 mm	INT. LOCK RINGS PLIERS, BENT - CIRC: Ø 12 ÷ 25 mm - BEAK: 28,5 mm - H: 12,5 mm	Pz. 1
PINZA PER AN EL. INT. PIEG. - AN: Ø 19 ÷ 60 mm - BECCO: 38 mm - H: 14 mm	INT. LOCK RINGS PLIERS, BENT - CIRC: Ø 19 ÷ 60 mm - BEAK: 38 mm - H: 14 mm	Pz. 1
PINZA PER AN EL. EST. DRI. - AN: Ø 3 ÷ 10 mm - BECCO: 40 mm	EXT. LOCK RINGS PLIERS, STRA. - CIRC: Ø 3 ÷ 10 mm - BEAK: 40 mm	Pz. 1
PINZA PER AN EL. EST. DRI. - AN: Ø 10 ÷ 25 mm - BECCO: 40 mm	EXT. LOCK RINGS PLIERS, STRA. - CIRC: Ø 10 ÷ 25 mm - BEAK: 40 mm	Pz. 1
PINZA PER AN EL. EST. DRI. - AN: Ø 19 ÷ 60 mm - BECCO: 52 mm	EXT. LOCK RINGS PLIERS, STRA. - CIRC: Ø 19 ÷ 60 mm - BEAK: 52 mm	Pz. 1
PINZA PER AN EL. EST. PIEG. - AN: Ø 3 ÷ 10 mm - BECCO: 285 mm - H: 125 mm	EXT. LOCK RINGS PLIERS, BENT - CIRC: Ø 3 ÷ 10 mm - BEAK: 28,5 mm - H: 12,5 mm	Pz. 1
PINZA PER AN EL. EST. PIEG. - AN: Ø 10 ÷ 25 mm - BECCO: 285 mm - H: 125 mm	EXT. LOCK RINGS PLIERS, BENT - CIRC: Ø 10 ÷ 25 mm - BEAK: 28,5 mm - H: 12,5 mm	Pz. 1
PINZA PER AN EL. EST. PIEG. - AN: Ø 19 ÷ 60 mm - BECCO: 38 mm - H: 14 mm	EXT. LOCK RINGS PLIERS, BENT - CIRC: Ø 19 ÷ 60 mm - BEAK: 38 mm - H: 14 mm	Pz. 1
TRONCHESA A TAGLIANTE DIAGONALE - La: 21 mm - BECCO: 20 mm	DIAGONAL CUTTING NIPPERS - Wi: 21 mm - BEAK: 20 mm	Pz. 1
PINZA UNIVERSALE - La: 27 mm - BECCO: 50 mm	COMBINATION PLIERS - Wi: 27 mm - BEAK: 50 mm	Pz. 1
PINZA A BECCHI LUNGI DIRITTI CON TAGLIANTE LAT. E PRESA TUBI - La: 17 mm - BECCO: 70 mm	LONG NOSE PLIERS WITH SIDE CUTTER AND PIPE GRIP STRA. - Wi: 17 mm - BEAK: 70 mm	Pz. 1
TOTALE	TOTAL	Pz. 17



EUT-FK-C8

Assortimento chiavi a t con bussola esagonale snodata
T-handle swivel hexagonal socket set

CHIAVE A T CON BUSSOLA ESAG. SNOIATA - 6 mm	T-HANDLE SWIVEL HEX. SOCKETS - 6 mm	Pz. 1
CHIAVE A T CON BUSSOLA ESAG. SNOIATA - 7 mm	T-HANDLE SWIVEL HEX. SOCKETS - 7 mm	Pz. 1
CHIAVE A T CON BUSSOLA ESAG. SNOIATA - 8 mm	T-HANDLE SWIVEL HEX. SOCKETS - 8 mm	Pz. 1
CHIAVE A T CON BUSSOLA ESAG. SNOIATA - 9 mm	T-HANDLE SWIVEL HEX. SOCKETS - 9 mm	Pz. 1
CHIAVE A T CON BUSSOLA ESAG. SNOIATA - 10 mm	T-HANDLE SWIVEL HEX. SOCKETS - 10 mm	Pz. 1
CHIAVE A T CON BUSSOLA ESAG. SNOIATA - 11 mm	T-HANDLE SWIVEL HEX. SOCKETS - 11 mm	Pz. 1
CHIAVE A T CON BUSSOLA ESAG. SNOIATA - 13 mm	T-HANDLE SWIVEL HEX. SOCKETS - 13 mm	Pz. 1
CHIAVE A T CON BUSSOLA ESAG. SNOIATA - 15 mm	T-HANDLE SWIVEL HEX. SOCKETS - 15 mm	Pz. 1
CHIAVE A T CON BUSSOLA ESAG. SNOIATA - 17 mm	T-HANDLE SWIVEL HEX. SOCKETS - 17 mm	Pz. 1
TOTALE	TOTAL	Pz. 9



EUT-FK-C13

Assortimento chiavi esagonali a t, torx e cacciapine
Hexagonal t handle, torx wrench and drift pins set

SERIE CHIAVI ESAG. CON ESTREMITÀ SFERICA, TIPO LUNGO MISURE: 1,5 - 2 - 2,5 - 3 - 4 - 5 - 6 - 8 - 10 mm	SET OF BALL END HEX. WRENCHES, LONG TYPE SIZES: 1,5 - 2 - 2,5 - 3 - 4 - 5 - 6 - 8 - 10 mm	Pz. 9
CACCIASPINE DA 2 mm A 6 mm x150 mm CR-MO	DRIFT PIN FROM 2 mm TO 6 mm x150 mm CR-MO	Pz. 5
CACCIASPINE DI 8X150MM CR-MO	DRIFT PIN DI 8X150MM CR-MO	Pz. 1
CHIAVE ESAG. MASCHIO A "T" - 2,5 mm	MALE "T" HANDLE HEX. WRENCHES - 2,5 mm	Pz. 1
CHIAVE ESAG. MASCHIO A "T" - 3 mm	MALE "T" HANDLE HEX. WRENCHES - 3 mm	Pz. 1
CHIAVE ESAG. MASCHIO A "T" - 4 mm	MALE "T" HANDLE HEX. WRENCHES - 4 mm	Pz. 1
CHIAVE ESAG. MASCHIO A "T" - 5 mm	MALE "T" HANDLE HEX. WRENCHES - 5 mm	Pz. 1
CHIAVE ESAG. MASCHIO A "T" - 6 mm	MALE "T" HANDLE HEX. WRENCHES - 6 mm	Pz. 1
CHIAVE ESAG. MASCHIO A "T" - 8 mm	MALE "T" HANDLE HEX. WRENCHES - 8 mm	Pz. 1
CHIAVE TORX T07 MASCHIO A "T" - 125x65 mm	MALE "T" T07 HANDLE TORX WRENCH - 125x65 mm	Pz. 1
CHIAVE TORX T08 MASCHIO A "T" - 125x65 mm	MALE "T" T08 HANDLE TORX WRENCH - 125x65 mm	Pz. 1
CHIAVE TORX T09 MASCHIO A "T" - 125x65 mm	MALE "T" T09 HANDLE TORX WRENCH - 125x65 mm	Pz. 1
CHIAVE TORX T10 MASCHIO A "T" - 125x65 mm	MALE "T" T10 HANDLE TORX WRENCH - 125x65 mm	Pz. 1
CHIAVE TORX T15 MASCHIO A "T" - 125x65 mm	MALE "T" T15 HANDLE TORX WRENCH - 125x65 mm	Pz. 1
CHIAVE TORX T20 MASCHIO A "T" - 125x65 mm	MALE "T" T20 HANDLE TORX WRENCH - 125x65 mm	Pz. 1
CHIAVE TORX T25 MASCHIO A "T" - 180x90 mm	MALE "T" T25 HANDLE TORX WRENCH - 180x90 mm	Pz. 1
CHIAVE TORX T30 MASCHIO A "T" - 180x90 mm	MALE "T" T30 HANDLE TORX WRENCH - 180x90 mm	Pz. 1
TOTALE	TOTAL	Pz.29



EUT-FK-C15

Assortimento chiave dinamometrica, chiavi a bussola e accessori
Torque wrenches, multi-sockets and accessories set

CHIAVI DINAMOMETRICHE CAP: 40 - 210 Nm - ATT: 1/2" - PREC: ±4%	TORQUE WRENCHES - CAP: 40 - 210 Nm SHANK: 1/2" ACCURAZ: ±4%	Pz. 1
CHIAVE A BUSS. POLIG., SERIE NORM. - 3/4"x55 mm	STD 12 POINT HAND SOCKET - 3/4"x55 mm	Pz. 1
CHIAVE A BUSS. POLIG., SERIE NORM. - 1/2"x DA 10 mm A 24 mm	STD 12 POINT HAND SOCKET - 1/2"x FROM 10 mm TO 24 mm	Pz.15
CHIAVE A BUSS. POLIG., SERIE NORM. - 1/2"x DA 26 mm A 27 mm	STD 12 POINT HAND SOCKET - 1/2"x FROM 26 mm TO 27 mm	Pz. 2
CHIAVE A BUSS. POLIG., SERIE NORM. - 1/2"x30 mm	STD 12 POINT HAND SOCKET - 1/2"x30 mm	Pz. 1
CHIAVE A BUSS. POLIG., SERIE NORM. - 1/2"x32 mm	STD 12 POINT HAND SOCKET - 1/2"x32 mm	Pz. 1
BUSS. CON INSERTO ESAG. LUNGO - 1/2"x5/6/8/10/12 mm	LONG HEX BIT SOCKET - 1/2"x5/6/8/10/12 mm	Pz. 5
RACCORDO - F.1/2" M.3/4"	ADAPTER - F.1/2" M.3/4"	Pz. 1
PROLUNGA - 150/250 mm	EXTENSION BAR - 150/250 mm	Pz. 2
SNODO A CARDAND	UNIVERSAL JOINT	Pz. 1
LEVA A T SCORREVOLE - 300 mm	SLIDING T BAR - 300 mm	Pz. 1
CRICCHETTO ERGONOMICO CON TESTA ANTISPORCO, 72 DENTI - 1/2"	DUST PROOF ERGONOMIC RATCHET HANDLE, 72 TEETH - 1/2"	Pz. 1
CHIAVE A BUSS. ESAG., SERIE NORM. - 3/4"x34/36/38/41/46/50 mm	STD 6 POINT HAND SOCKET 3/4"x34/36/38/41/46/50 mm	Pz. 6
CHIAVE A BUSS. PER CANDELA - 1/2"x16/18/21 mm	SPARK PLUG SOCKET - 1/2"x16/18/21 mm	Pz. 3
TOTALE	TOTAL	Pz.41



EUT-FK-C17

Assortimento martelli, lime e calibro elettronico digitale
Hammers, steel files and electronic digital caliper set

MARTELLO TIPO TEDESCO - 400 gr MACHINIST'S HAMMER GERMAN TYPE - 40 gr	MACHINIST'S HAMMER GERMAN TYPE - 40 gr	Pz. 1
MAZZUOLO - ø 35 mm	MALLET - ø 35 mm	Pz. 1
LIME PER MECCANICA RETTANGOLARI CON TAGLIO MEZZO DOLCE	RECTANGULAR HALF CUT STEEL FILE	Pz. 1
LIME PER MECCANICA TONDE CON TAGLIO MEZZO DOLCE	ROUND HALF CUT STEEL FILE	Pz. 1
CALIBRO EL. DIG. - RANGE: 0 ÷ 150 mm - 0 ÷ 6 PRECISIONE: 0,02 mm	EL. DIG. CALIPER - RANGE: 0 ÷ 150 mm - 0 ÷ 6" - ACC.: 0,02 mm	Pz. 1
KIT DI ISPEZIONE DA 7PZ CONTENENTE: • Dispositivo di presa con artiglio; • Tubo semi-rigido - l. 400 mm; • Barra tel. in acciaio inox con rilascio veloce, presa antiscivolo, lung. di funz. di 530 mm; • Inserto con luce nicchia led ultra intensa, batt. 3 x 1.5 v incl. (tip. Ir44); • Inserto con magnete potente; • Specchietti di controllo, senza alterazioni visive, installati in una cornice in acciaio inox, ruotabile di 360°; • specchio di ø50 mm e specchio rettangolare di 60x40 mm; • Vassoio magn. in acciaio inox con fondo magn. perm. - ø110 mm;	7 PCS SET INSPECTION TOOL KIT CONTAINING: • Quality claw pick-up device; • Semi-rigid hose - l. 400 mm; • Stainless steel telescope bar with quick release, non-slip grip, 530 mm working length; • Socket with ultra bright nicchia led light, incl. 3 x 1.5 v battery (type Ir44); • Socket with powerful magnet; • Inspection mirrors, with perfect reflection, no deterioration, mounted in a stainless steel frame, 360° rotatable one mirror in ø50 mm and one mirror rectangular 60 x 40 mm; • Stainless steel tray with perm. magnetic bottom - ø110 mm	Pz.7
SET DI TRE PINZE IN NYLON STRINGI TUBO ø MAX TUBO: 10 - 15 - 24 mm	NYLON CLAMP SET - MAX HOSE ø: 10 - 15 - 24 mm	Pz.3
TOTALE	TOTAL	Pz.15



MOTO
PLEX



PIAGGIO®



KYMCO



Husqvarna
MOTORCYCLES



ELEVATE

Via A. Novella, 46
CAP 43058 - Sorbolo (PR) - ITALY
Ph. +39 0522 687907
Fax +39 0522 684498
www.lv8elevate.it - info@lv8.it

www.lv8elevate.it



Follow us on social media



ELEVATE

Via A. Novella, 46
CAP 43058 - Sorbolo (PR) - ITALY
Ph. +39 0522 687907
Fax +39 0522 684498
www.lv8elevate.it - info@lv8.it

www.lv8elevate.it

Tutti i diritti riservati. Ogni riproduzione, anche parziale, del presente catalogo è vietata senza previa autorizzazione scritta. Il produttore si riserva il diritto di modificare od implementare la gamma dei prodotti a catalogo in qualsiasi momento e senza preavviso.

All rights reserved. Any reproduction, even partial, of the present catalogue is not allowed without any previous written authorization. The Manufacturer reserves the right to change or implement the range of the products in this catalogue at any time and without previous notice.